



# SERVICE MANUAL

Product Type : Digital-to-Analog Converter Box  
Chassis :  
Manual Series : DTT900  
Manual Part # : AFN32135816  
Model Line : D  
Product Year : 2007

Model Series:  
DTT900

CONTENTS	
SECTION 1	SUMMARY
SECTION 2	CABINET & MAIN CHASSIS
SECTION 3	ELECTRICAL
SECTION 4	REPLACEMENT PARTS LIST

Published November 2007  
by Technical Publications  
Zenith Electronics Corporation  
201 James Record Road  
Huntsville, Alabama 35824-1513

Copyright © 2007 by Zenith Electronics Corporation

Printed in U.S.A.

SERVICE MANUAL

MODEL : DTT900



## **CONTENTS**

- SECTION 1.....SUMMARY**
- SECTION 2.....CABINET & MAIN CHASSIS**
- SECTION 3.....ELECTRICAL**
- SECTION 4.....REPLACEMENT PARTS LIST**

# SECTION 1

## SUMMARY

### CONTENTS

<b>PRODUCT SAFETY SERVICING GUIDELINES FOR DIGITAL-TO-ANALOG CONVERTER BOX PRODUCTS</b> .....	1-3
<b>SERVICING PRECAUTIONS</b> .....	1-4
• GENERAL SERVICING PRECAUTIONS	
• INSULATION CHECKING PRODEDURE	
• ELECTROSTATICALLY SENSITIVE (ES) DEVICES	
<b>SOFTWARE UPGRADE</b> .....	1-5
<b>SPECIFICATIONS</b> .....	1-10

# PRODUCT SAFETY SERVICING GUIDELINES FOR DIGITAL-TO-ANALOG CONVERTER BOX PRODUCTS

## IMPORTANT SAFETY NOTICE

This manual was prepared for use only by properly trained audio-video service technicians.

When servicing this product, under no circumstances should the original design be modified or altered without permission from Zenith. All components should be replaced only with types identical to those in the original circuit and their physical location, wiring and lead dress must conform to original layout upon completion of repairs.

Special components are also used to prevent x-radiation, shock and fire hazard. These components are indicated by the letter "X" included in their component designators and are required to maintain safe performance. No deviations are allowed without prior approval by Zenith.

Circuit diagrams may occasionally differ from the actual circuit used. This way, implementation of the latest safety and performance improvement changes into the set are not delayed until the new service literature is printed.

**CAUTION:** Do not attempt to modify this product in any way. Never perform customized installations without manufacturer's approval. Unauthorized modifications will not only void the warranty but may lead to property damage or user injury.

Service work should be performed only after you are thoroughly familiar with these safety checks and servicing guidelines.

## GRAPHIC SYMBOLS



The exclamation point within an equilateral triangle is intended to alert the service personnel to important safety information in the service literature.



The lightning flash with arrowhead symbol within an equilateral triangle is intended to alert the service personnel to the presence of non-insulated "dangerous voltage" that may be of sufficient magnitude to constitute a risk of electric shock.



The pictorial representation of a fuse and its rating within an equilateral triangle is intended to convey to the service personnel the following fuse replacement caution notice:

**CAUTION: FOR CONTINUED PROTECTION AGAINST RISK OF FIRE, REPLACE ALL FUSES WITH THE SAME TYPE AND RATING AS MARKED NEAR EACH FUSE.**

## SERVICE INFORMATION

While servicing, use an isolation transformer for protection from AC line shock. After the original service problem has been corrected, make a check of the following:

## FIRE AND SHOCK HAZARD

1. Be sure that all components are positioned to avoid a possibility of adjacent component shorts. This is especially important on items transported to and from the repair shop.
2. Verify that all protective devices such as insulators, barriers, covers, shields, strain reliefs, power supply cords, and other hardware have been reinstalled per the original design. Be sure that the safety purpose of the polarized line plug has not been defeated.
3. Soldering must be inspected to discover possible cold solder joints, solder splashes, or sharp solder points. Be certain to remove all loose foreign particles.
4. Check for physical evidence of damage or deterioration to parts and components, for frayed leads or damaged insulation (including the AC cord) and replace if necessary.
5. No lead or component should touch a high current device or a resistor rated at 1 watt or more. Lead tension around protruding metal surfaces must be avoided.
6. After reassembly of the set, always perform an AC leakage test on all exposed metallic parts of the cabinet (the channel selector knobs, antenna terminals, handle and screws) to be sure that set is safe to operate without danger of electrical shock. **DO NOT USE A LINE ISOLATION TRANSFORMER DURING THIS TEST.** Use an AC voltmeter having 5000 ohms per volt or more sensitivity in the following manner: Connect a 1500 ohm, 10 watt resistor, paralleled by a .15 mfd 150V AC type capacitor between a known good earth ground (water pipe, conduit, etc.) and the exposed metallic parts, one at a time. Measure the AC voltage across the combination of 1500 ohm resistor and .15 mfd capacitor. Reverse the AC plug by using a non-polarized adaptor and repeat AC voltage measurements for each exposed metallic part. Voltage measured must not exceed 0.75 volts RMS. This corresponds to 0.5 millamp AC. Any value exceeding this limit constitutes a potential shock hazard and must be corrected immediately.

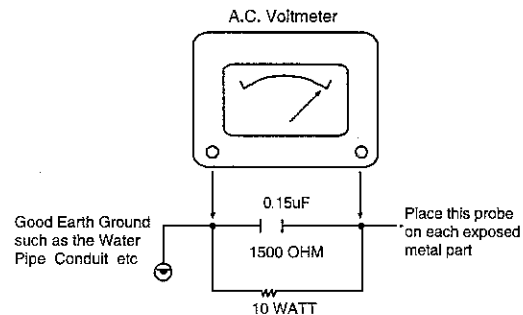

## TIPS ON PROPER INSTALLATION

1. Never install any receiver in a closed-in recess, cubbyhole, or closely fitting shelf space over or close to a heat duct or in the path of heated air flow.
2. Avoid conditions of high humidity such as: outdoor patio installations where dew is a factor, near steam radiators where steam leakage is a factor, etc.
3. Avoid placement where draperies may obstruct venting. The customer should also avoid the use of decorative scarves or other coverings that might obstruct ventilation.
4. Wall- and shelf-mounted installations using a commercial mounting kit must follow the factory-approved mounting instructions. A product mounted to a shelf or platform must retain its original feet (or the equivalent thickness in spacers) to provide adequate air flow across the bottom. Bolts or screws used for fasteners must not touch any parts or wiring. Perform leakage tests on customized installations.
5. Caution customers against mounting a product on a sloping shelf or in a tilted position, unless the receiver is properly secured.
6. A product on a roll-about cart should be stable in its mounting to the cart. Caution the customer on the hazards of trying to roll a cart with small casters across thresholds or deep pile carpets.
7. Caution customers against using extension cords. Explain that a forest of extensions, sprouting from a single outlet, can lead to disastrous consequences to home and family.

# SERVICING PRECAUTIONS

CAUTION: Before servicing the Digital-to-Analog Converter Box covered by this service data and its supplements and addends, read and follow the SAFETY PRECAUTIONS NOTE: if unforeseen circumstances create conflict between the following servicing precautions and any of the safety precautions in this publication, always follow the safety precautions

Remember Safety First:

## General Servicing Precautions

1 Always unplug the Digital-to-Analog Converter Box AC power cord from the AC power source before:

- (1) Removing or reinstalling any component, circuit board, module, or any other assembly
- (2) Disconnecting or reconnecting any internal electrical plug or other electrical connection
- (3) Connecting a test substitute in parallel with an electrolytic capacitor

**Caution:** A wrong part substitution or incorrect polarity installation of electrolytic capacitors may result in an explosion hazard.

2 Do not spray chemicals on or near this Digital-to-Analog Converter Box or any of its assemblies

3 Unless specified otherwise in this service data, clean electrical contacts by applying an appropriate contact cleaning solution to the contacts with a pipe cleaner, cotton-tipped swab, or comparable soft applicator

Unless specified otherwise in this service data, lubrication of contacts is not required

4 Do not defeat any plug/socket B+ voltage interlocks with which instruments covered by this service manual might be equipped

5 Do not apply AC power to this Digital-to-Analog Converter Box and / or any of its electrical assemblies unless all solid state device heat sinks are correctly installed

6 Always connect the test instrument ground lead to an appropriate ground before connecting the test instrument positive lead. Always remove the test instrument ground lead last

## Insulation Checking Procedure

Disconnect the attachment plug from the AC outlet and turn the power on. Connect an insulation resistance meter (500V) to the blades of the attachment plug. The insulation resistance between each blade of the attachment plug and accessible conductive parts (Note 1) should be more than 1Mohm

**Note 1:** Accessible Conductive Parts include Metal panels, Input terminals, Earphone jacks, etc.

## Electrostatically Sensitive (ES) Devices

Some semiconductor (solid state) devices can be damaged easily by static electricity. Such components commonly are called Electrostatically Sensitive (ES) Devices. Examples of typical ES devices are integrated circuits and some field effect transistors and semiconductor chip components.

The following techniques should be used to help reduce the incidence of component damage caused by static electricity

1 Immediately before handling any semiconductor component or semiconductor-equipped assembly, drain off any electrostatic charge on your body by touching a known earth ground. Alternatively, obtain and wear a commercially available discharging wrist strap device, which should be removed for potential shock reasons prior to applying power to the unit under test

2 After removing an electrical assembly equipped with ES devices, place the assembly on a conductive surface such as aluminum foil, to prevent electrostatic charge buildup or exposure of the assembly

3 Use only a grounded-tip soldering iron to solder or unsolder ES devices

4 Use only an anti-static solder removal device. Some solder removal devices not classified as "anti-static" can generate electrical charges sufficient to damage ES devices

5 Do not use freon-propelled chemicals. These can generate an electrical charge sufficient to damage ES devices.

6 Do not remove a replacement ES device from its protective package until immediately before you are ready to install it. (Most replacement ES devices are packaged with leads electrically shorted together by conductive foam, aluminum foil, or comparable conductive material)

7 Immediately before removing the protective material from the leads of a replacement ES device, touch the protective material to the chassis or circuit assembly into which the device will be installed

**Caution:** Be sure no power is applied to the chassis or circuit, and observe all other safety precautions

8 Minimize bodily motions when handling unpackaged replacement ES devices. (Normally harmless motion such as the brushing together of your clothes fabric or the lifting of your foot from a carpeted floor can generate static electricity sufficient to damage an ES device.)

# SOFTWARE UPGRADE

## 1. TOOL CONNECTION METHOD AND SOFTWARE SETUP

### 1-1. Serial cable installation between PC and this unit

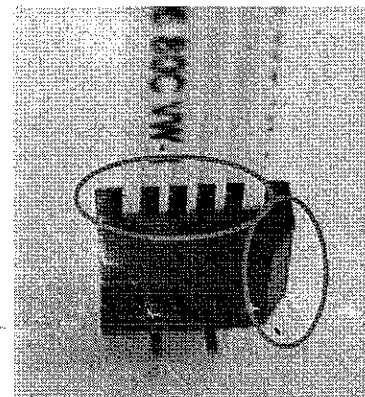
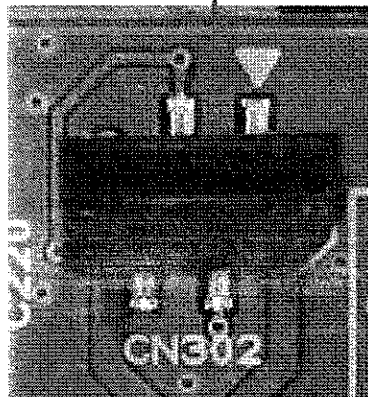
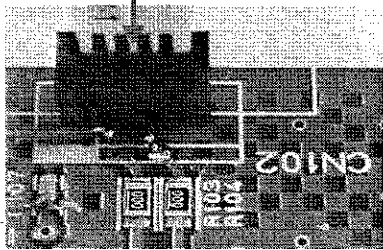
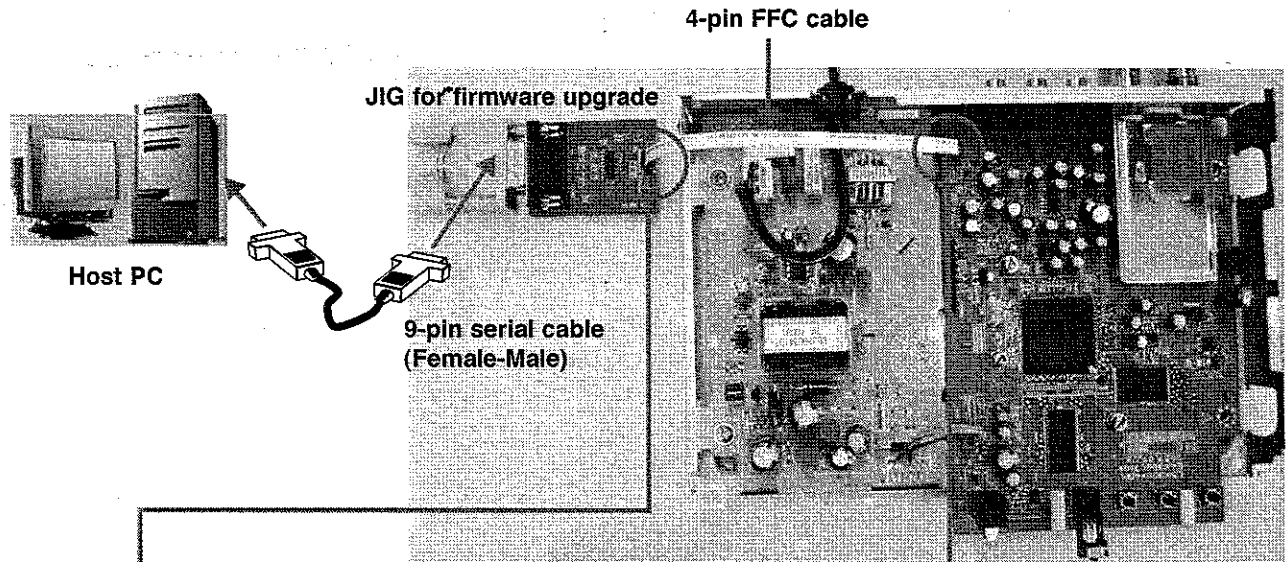

- 1) Connect one end of the serial cable to COM1 or COM2 terminal of HOST PC. (female)
- 2) Connect the other end of the serial cable to the JIG for upgrade. (male)
- 3) Connect the CN102 of JIG for upgrade and CN302 of main board with 4pin FFC cable.
- 4) When connecting the cable, make sure that the corner part of the connector and the pad part of the cable are in the same direction. (Refer to Fig. 4)

## 1-2. Serial communication SW installation between PC and this unit

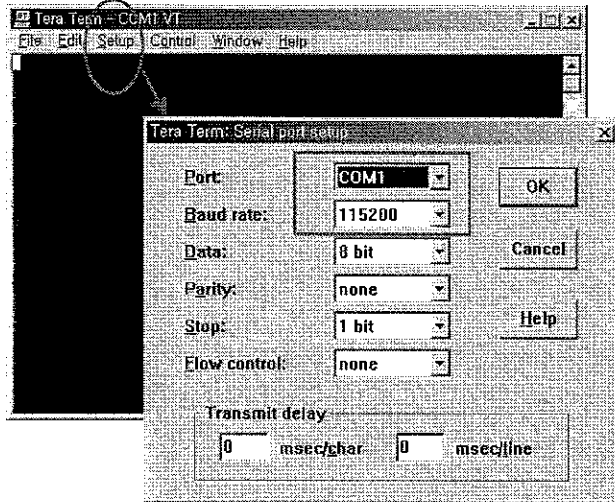

< Fig. 1 >

- 1) For the software to enable serial communication, install the communication program that you can easily obtain such as Hyper Terminal included in Windows or Tera Term etc. from the website. (Here, the descriptions are assuming the installation of Tera Term.)
- 2) Setting serial communication
  - Port setting : Connect the serial cable to unused port among COM1, COM2..., and use the cable and port.
  - Transmission speed : 115200 bps
  - \* Maintain default for remaining setting.

## 1-3. Software Upgrade



< Fig. 1 >

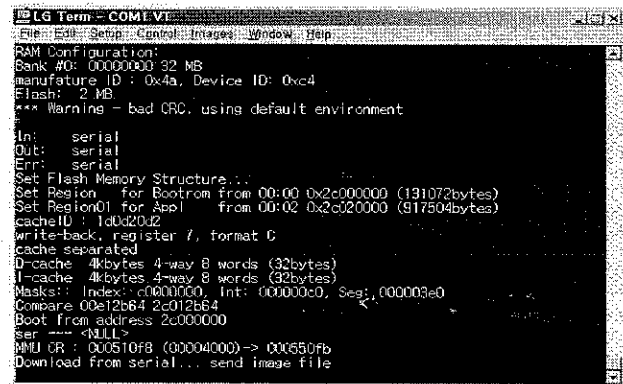

< Fig. 2 >

- 1) Connect the cable for serial communication with the PC.
- 2) Run the Tera Term program.
- 3) Turn on the power of this unit
- 4) Enter the password from Tera Term terminal  
=> "1D2A"
- 5) Enter "D" to see "Fig. 1".
- 6) When you enter "F0" from "Fig. 1", "Fig. 2" will be displayed.  
=> The file must be transmitted in 1 minute

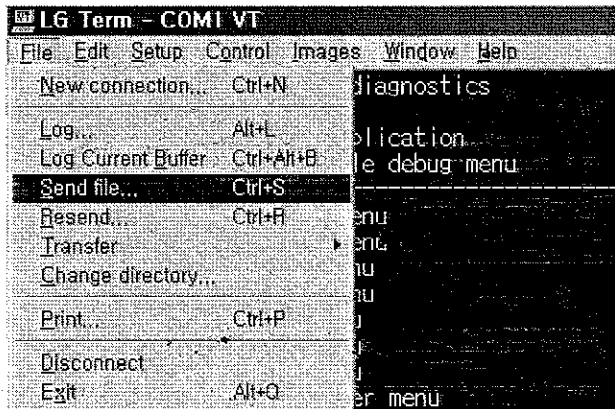

< Fig. 3 >

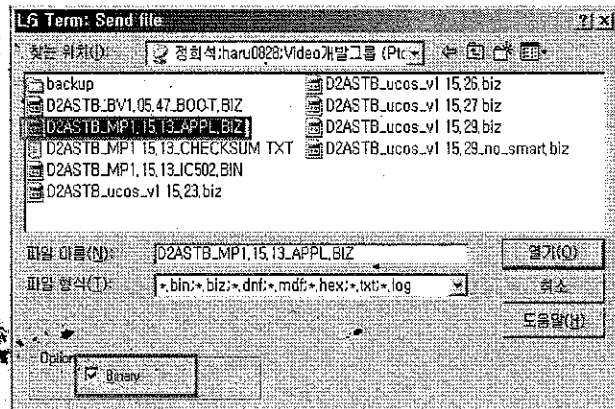

< Fig. 4 >

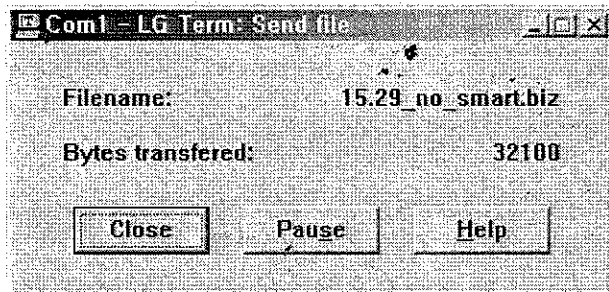

< Fig. 5 >

- 7) Select "Send file..." from the terminal menu. (Fig. 3)
- 8) When the file selection window is open, select the file to transmit.  
At this time, you must always send in binary condition. (Fig. 4)
- 9) The file transmission process is displayed. During this operation, do not operate the terminal and wait until the process is completed. (Fig. 5)  
It requires about 90 seconds.

## 1-4. Execute software upgrade

```

LGE Term - COM1-VT - WWW\idm\ID-no3219\IMAGES\WD2AS1B-nvcs-v1.15.23-no-rtm\07
File Edit Setup Control Images Windows Help
-- Checking CRC32 [Bin 1] -- Good, in 0.142 sec
Moving 8841 symbols (268690 bytes) from 0x01aead0 to 0x002f2a58
Load image to 00010000...
Start from 00010000
MMU CR : 000540fb (00004000) -> 000540fa
[sect: 2, src:0x7f9950, dst:0x2c020000, ssz:0x10000, wsz:0x10000] -> Erasing, Writing -> Done
[sect: 3, src:0x80f950, dst:0x2c030000, ssz:0x10000, wsz:0x10000] -> Skip
[sect: 4, src:0x81f950, dst:0x2c040000, ssz:0x10000, wsz:0x10000] -> Skip
[sect: 5, src:0x82f950, dst:0x2c050000, ssz:0x10000, wsz:0x10000] -> Skip
[sect: 6, src:0x83f950, dst:0x2c060000, ssz:0x10000, wsz:0x10000] -> Skip
[sect: 7, src:0x84f950, dst:0x2c070000, ssz:0x10000, wsz:0x10000] -> Skip
[sect: 8, src:0x85f950, dst:0x2c080000, ssz:0x10000, wsz:0x10000] -> Skip
[sect: 9, src:0x86f950, dst:0x2c090000, ssz:0x10000, wsz:0x10000] -> Skip
[sect: 10, src:0x87f950, dst:0x2c0a0000, ssz:0x10000, wsz:0x10000] -> Skip
[sect: 11, src:0x88f950, dst:0x2c0b0000, ssz:0x10000, wsz:0x10000] -> Skip
[sect: 12, src:0x89f950, dst:0x2c0c0000, ssz:0x10000, wsz:0x10000] -> Skip
[sect: 13, src:0x8af950, dst:0x2c0d0000, ssz:0x10000, wsz:0x10000] -> Skip
[sect: 14, src:0x8bf950, dst:0x2c0e0000, ssz:0x10000, wsz:0x10000] -> Skip
[sect: 15, src:0x8cf950, dst:0x2c0f0000, ssz:0x10000, wsz:0x10000] -> Skip
[sect: 16, src:0x8df950, dst:0x2c100000, ssz:0x10000, wsz:0x10000] -> Skip
[sect: 17, src:0x8ef950, dst:0x2c110000, ssz:0x10000, wsz:0x10000] -> Skip
Update flash takes 2.705 s
cacheID : 1d0c20e2
write-back, register 7, format C
cache separated
D-cache 4kbytes, 4-way, 8 words (32bytes)
I-cache 4kbytes, 4-way, 8 words (32bytes)
Masks: Index: c0000000, Int: 000000e0, Seg: 000003e0
MMU CR : 000550fa (00004000) -> 000550ff
n1xtSyms... = 8841
pSymTabBase = 0x272a8c...0x278b18
pSymHashBase = 0x278b1c...0x280350
pSymStrBase = 0x293d2e9...0x2b7cda
pDwarfList = 207
pDwarfList = 0x27a09c...0x27a714
pDwarfData = 0x27a714...0x022b05
000.025:root | >> InitPool [1] [0x002b8000-0x01000000]
000.025:root | SM_MAT_POOL [4] = 0x002b9000(0x004000)
000.027:root | SM_MAT_POOL [8] = 0x002ba000(0x008000)
000.028:root | SM_MAT_POOL [16] = 0x002bb000(0x010000)
000.029:root | SM_MAT_POOL [32] = 0x002bc000(0x020000)
000.030:root | SM_MAT_POOL [64] = 0x002bd000(0x040000)
000.031:root | >> InitBuddy [1] Addr=0x3b0000, Size=0xc50000
000.033:root | >> Total Free Heap Size = 0xd1c000
Stack : 396860180 0024fbc4
New Application booted, uart = 0xfe100000, baud = 115200
Starting V1.15.23, Aug 8 2007, 16:59:33, from klink inam@chenix04201:/cyadriver/d/work/vss/hmc/app/d2astb

```

< Fig. 1 >

- 1) Check the process of saving the software on the flash ( Fig. 1)
- 2) Check version
- 3) Check the rebooting of the set.

### Software Upgrade

## 2. METHOD OF ENTERING BOOT MODE AND UPGRADING WHEN THE APPLICATION CODE IS BROKE

### 2-1. Execute upgrade in BOOT mode

```

LG Term - COM1-VT
File Edit Setup Control Images Window Help
VT.05.47 Aug 20 2007, 19:13:47 @ /d/SRC/WORK/BOOT
Config Baud Rate : 115200 bps
System Clock Rate : 175 MHz
U-Boot Mem offset : Text/Data [00e00000, 00e18487], BSS [00e18489, 00e3a7b7]

RAM Configuration:
Bank #0: 00000000 32 MB
manufacture ID : 0x4a, Device ID: 0xc4
Flash: 2 MB
*** Warning - bad CRC, using default environment

In: serial
Out: serial
Err: serial

Set Flash Memory Structure...
Set Region for Bootrom from 00:00 0x2c000000 (131072bytes)
Set Region01 for Appl from 00:02 0x2c020000 (917504bytes)
cacheID : 1d0d20d2
write-back, register 7, format 0
cache separated
D-cache 4kbytes 4-way 8 words (32bytes)
I-cache 4kbytes 4-way 8 words (32bytes)
Masks: Index: c0000000, Int: 000000c0, Seg: 000000e0
Command: 00a12ae0 2c012ae8
Boot from address 2c000000
Boot from flash
BOOT!!!
MMU CR : 000510f8 (00004000) -> 000550fb
Processing BIZ file-from Flash: 0x2c020000
Aux data is symbol table(335454 bytes), pSymTab=0x1a97c8
[Application Code]
Loading[4] Image from 2c020800 to 00010000(+1369961)
-- TRY 0 ==> 2012710 bytes loaded in 0.262 sec, rc=0
-- Checking CRC32[Bin ] ==> mismatch header(0x45e07ad8) != real(0xde9bcab5)
-- TRY 1 ==> 2012710 bytes loaded in 0.261 sec, rc=0
-- Checking CRC32[Bin ] ==> mismatch header(0x45e07ad8) != real(0xde9bcab5)
-- TRY 2 ==> 2012710 bytes loaded in 0.261 sec, rc=0
-- Checking CRC32[Bin ] ==> mismatch header(0x45e07ad8) != real(0xde9bcab5)
Extracting code/data failed: can not read code/data
MMU CR : 000540fb (00004000) -> 000540fa
Hit any key to stop autoboot: 0
Flash <NULL>
MMU CR : 000540fa (00004000) -> 000540fb
Latest Biz section(1): 0x2c020000
Processing BIZ file-from Flash: 0x2c020000
Aux data is symbol table(335454 bytes), pSymTab=0x1a97c8
[Application Code]
Loading[5] Image from 2c020800 to 00010000(+1369961)
-- TRY 0 ==> 2012710 bytes loaded in 0.272 sec, rc=0
-- Checking CRC32[Bin ] ==> mismatch header(0x45e07ad8) != real(0xde9bcab5)
-- TRY 1 ==> 2012710 bytes loaded in 0.272 sec, rc=0
-- Checking CRC32[Bin ] ==> mismatch header(0x45e07ad8) != real(0xde9bcab5)
-- TRY 2 ==> 2012710 bytes loaded in 0.272 sec, rc=0
-- Checking CRC32[Bin ] ==> mismatch header(0x45e07ad8) != real(0xde9bcab5)
Extracting code/data failed: can not read code/data
Fail to unzip biz
MMU CR : 000540fb (00004000) -> 000540fa
[D2A-STB #] boot ser f
ser --- <NULL>
MMU CR : 000540fb (00004000) -> 000540fb
Download from serial... send image file
  
```

< Fig. 1 >

- 1) Connect the this unit and the serial cable, and open TeraTerm.
- 2) Enter boot ser fin small letters on the terminal and then press the ENTER button.

```

LG Term - COM1-VT
File Edit Setup Control Images Window Help

[D2A-STB #]
[D2A-STB #]
[D2A-STB #]
[D2A-STB #]
[D2A-STB #]
[D2A-STB #] boot ser f
ser --- <NULL>
MMU CR : 000540fb (00004000) -> 000540fb
Download from serial... send image file
  
```

< Fig. 2 >

When the "Download from Serial... Send image file" message is displayed as shown in Fig. 2, the file will be transmitted in the same method as described in pages 1-7 and 1-8.

\* If, the transmission fails again, repeat this page.

# SPECIFICATIONS

## • GENERAL

Television System:	DTV standard ATSC
Channel Coverage:	Terrestrial 2-69
Dimensions (W x H x D):	Approx. 8.5 x 1.8 x 6.4 inches (215 x 46 x 162mm)
Net Weight):	Approx. 1.65lbs (0.75kg)
Operating temperature:	41°F to 104°F (5°C to 40°C)
Operating humidity:	5% to 90%
Power requirement:	120V ~ 60Hz AC
Power consumption:	7W

## • INPUT/OUTPUT

ANTENNA IN (FROM ANT):	Antenna input, ATSC, 75Ω
ANTENNA OUT (TO TV):	Antenna output, 75Ω, RF Output Channel 3 or 4 (Switchable)
VIDEO OUTPUT:	1.0V (p-p), 75Ω, negative sync, RCA jack x 1
AUDIO OUTPUT:	2.0Vrms (1kHz, 0dB), 600Ω, RCA jack (L, R) x 1

# SECTION 2

## CABINET & MAIN CHASSIS

### CONTENTS

<b>EXPLODED VIEWS</b> .....	2-2
1. CABINET AND MAIN FRAME SECTION .....	2-2
2. PACKING ACCESSORY SECTION .....	2-3

# EXPLODED VIEWS

## 1. CABINET AND MAIN FRAME SECTION

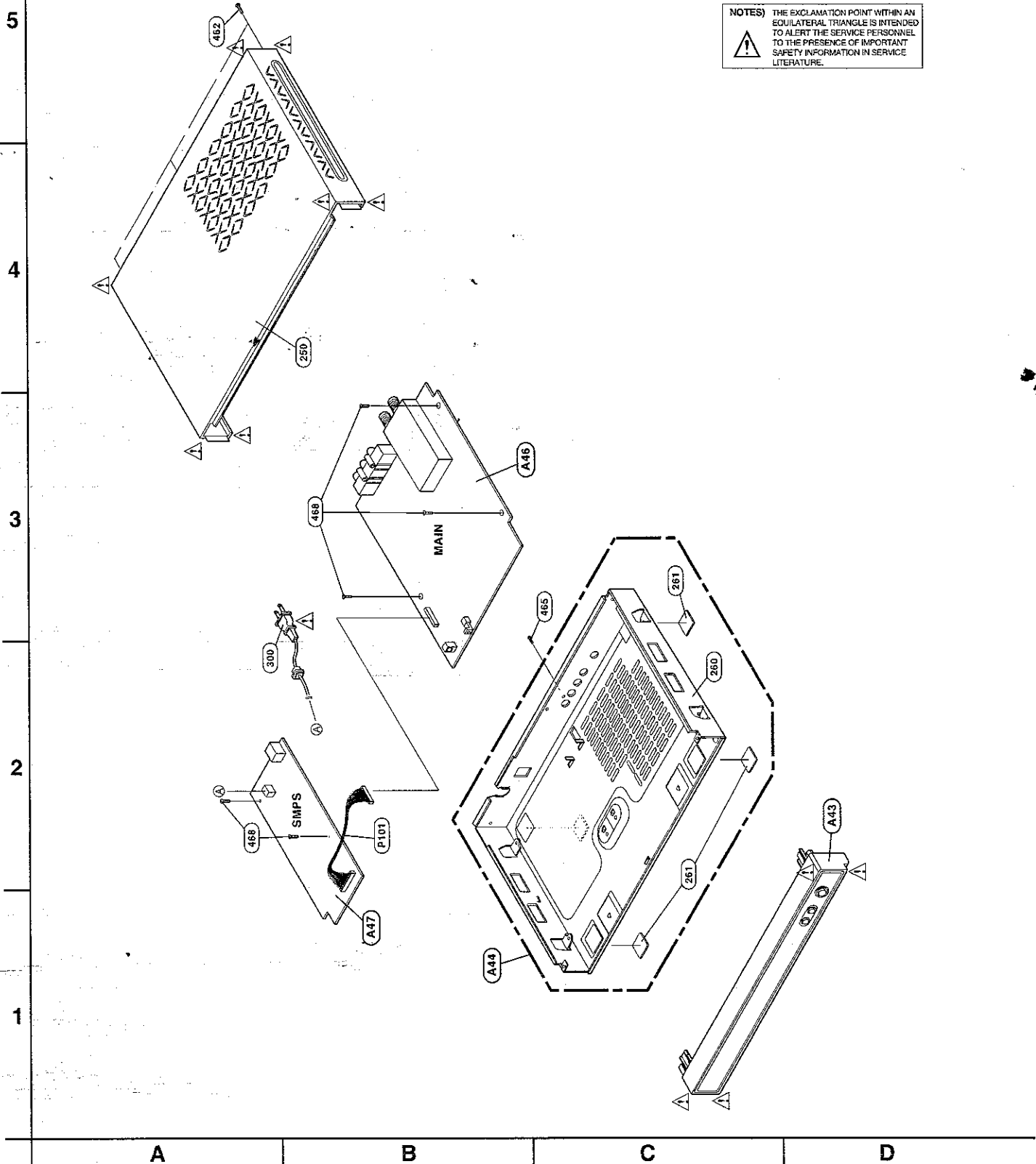

**NOTES)** THE EXCLAMATION POINT WITHIN AN EQUILATERAL TRIANGLE IS INTENDED TO ALERT THE SERVICE PERSONNEL TO THE PRESENCE OF IMPORTANT SAFETY INFORMATION IN SERVICE LITERATURE.

## 2. PACKING ACCESSORY SECTION

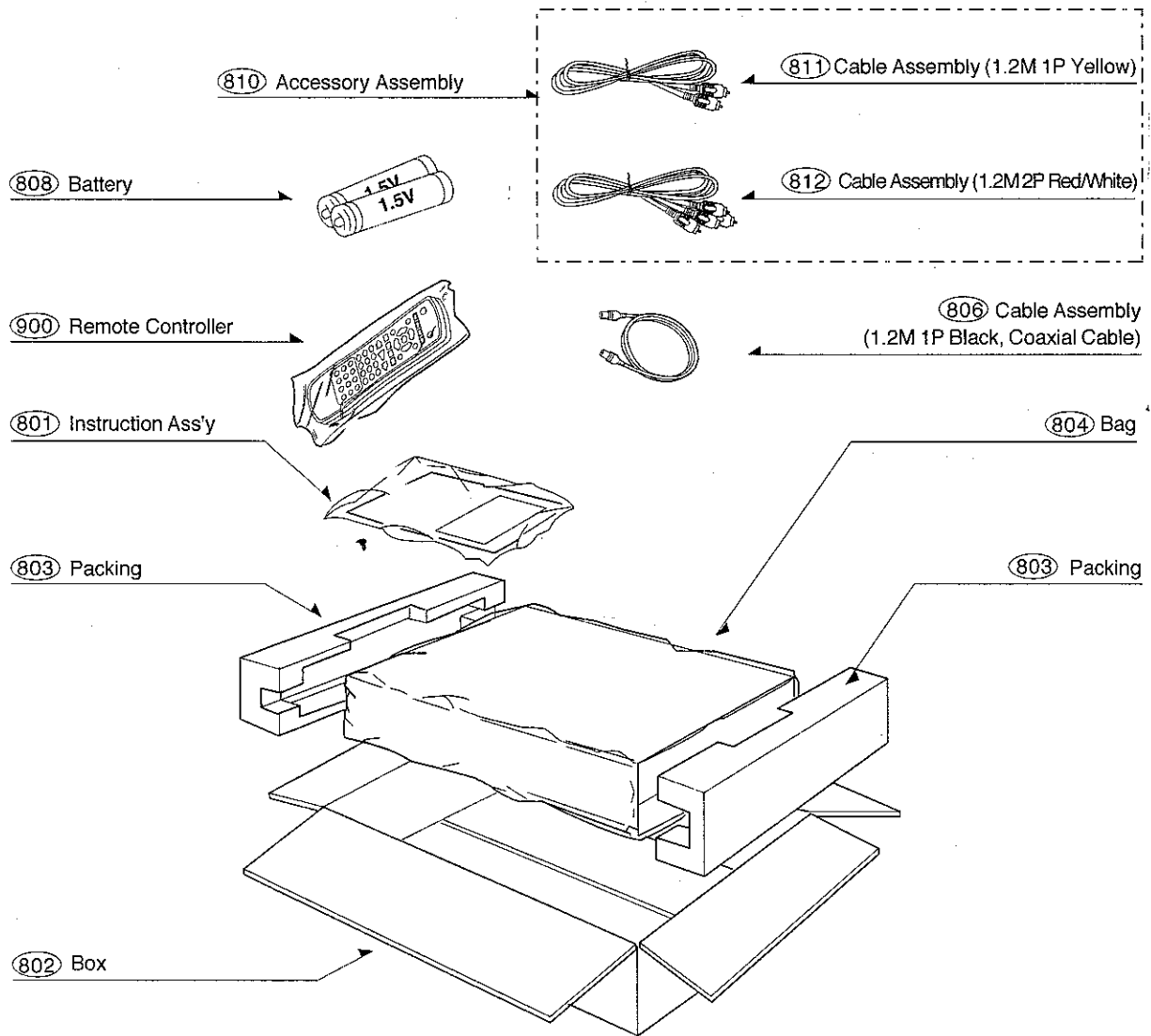

# MEMO

# SECTION 3

## ELECTRICAL

### CONTENTS

<b>ELECTRICAL TROUBLESHOOTING GUIDE &amp; WAVEFORMS</b> .....	3-2
1. POWER SUPPLY PART .....	3-2
2. FRONT PANEL PART .....	3-4
3. RF FRONT-END PART (ATSC VSB) .....	3-6
4. AUDIO PART .....	3-8
5. VIDEO PART .....	3-11
6. SYSTEM (CPU) PART .....	3-13
 <b>WIRING DIAGRAM</b> .....	 3-18
 <b>BLOCK DIAGRAMS</b> .....	 3-19
1. POWER (SMPS) BLOCK DIAGRAM .....	3-19
2. OVERALL BLOCK DIAGRAM .....	3-20
 <b>CIRCUIT DIAGRAMS</b> .....	 3-21
1. POWER (SMPS) CIRCUIT DIAGRAM .....	3-21
2. ANALOG CIRCUIT DIAGRAM .....	3-23
3. MISC CIRCUIT DIAGRAM .....	3-25
4. SYSTEM CIRCUIT DIAGRAM .....	3-27
5. MEMORY CIRCUIT DIAGRAM .....	3-29
6. FRONT PANEL CIRCUIT DIAGRAM .....	3-31
 <b>PRINTED CIRCUIT BOARD DIAGRAMS</b> .....	 3-33
1. MAIN P.C. BOARD .....	3-33
2. POWER (SMPS) P.C. BOARD .....	3-35

# ELECTRICAL TROUBLESHOOTING GUIDE & WAVEFORMS

## 1. POWER SUPPLY PART

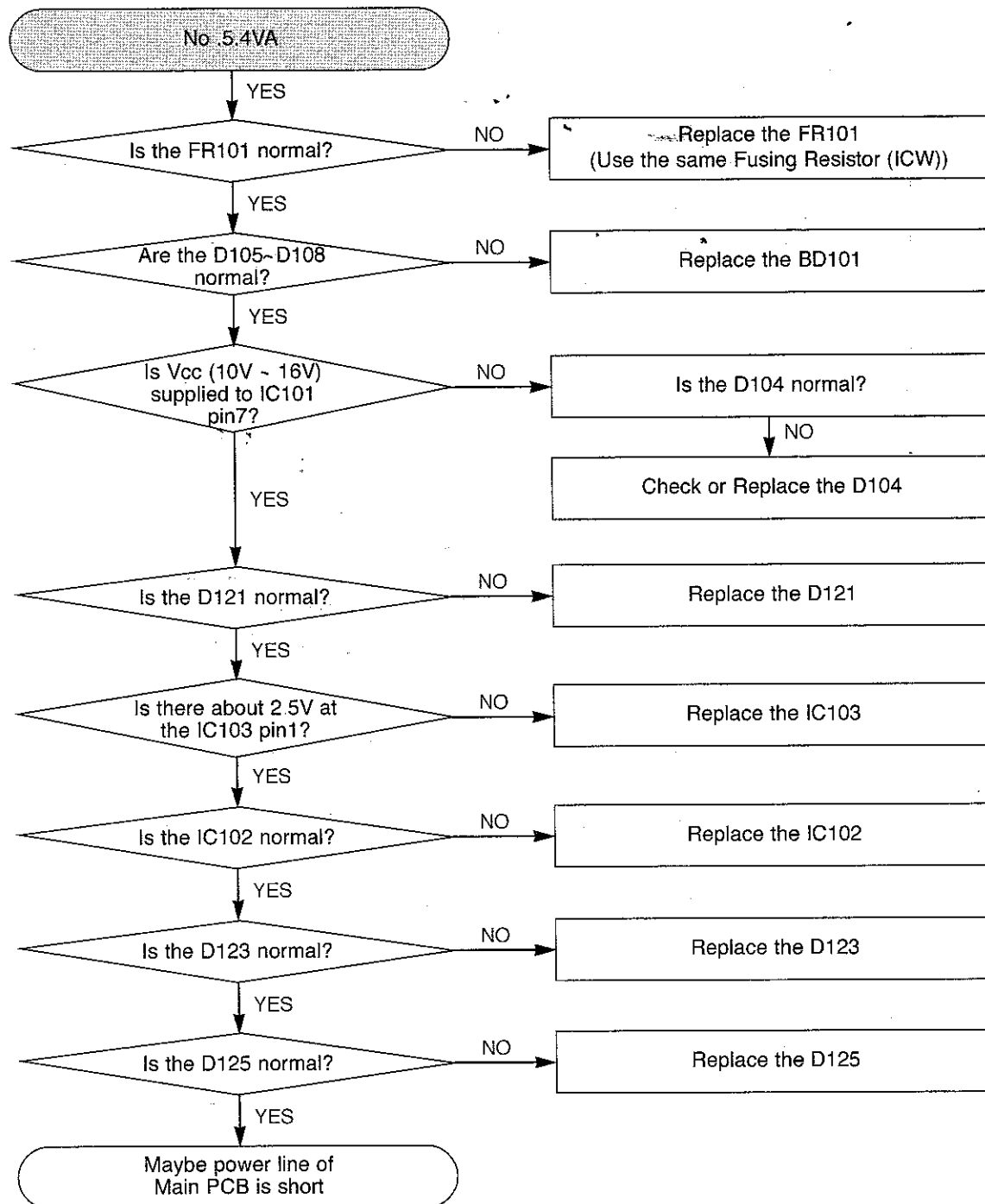

# ELECTRICAL TROUBLESHOOTING GUIDE & WAVEFORMS

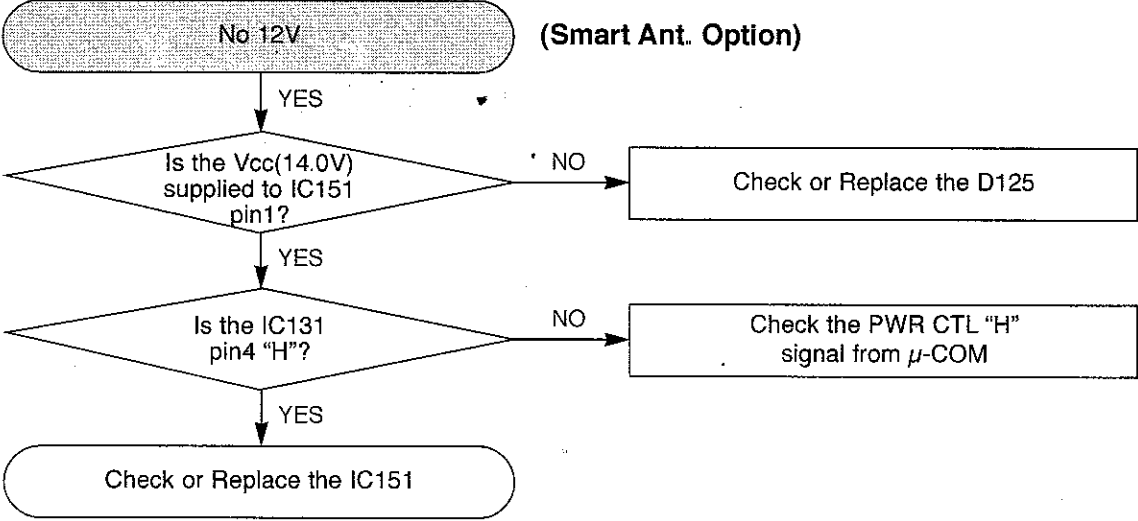

# ELECTRICAL TROUBLESHOOTING GUIDE & WAVEFORMS

## 2. FRONT PANEL PART

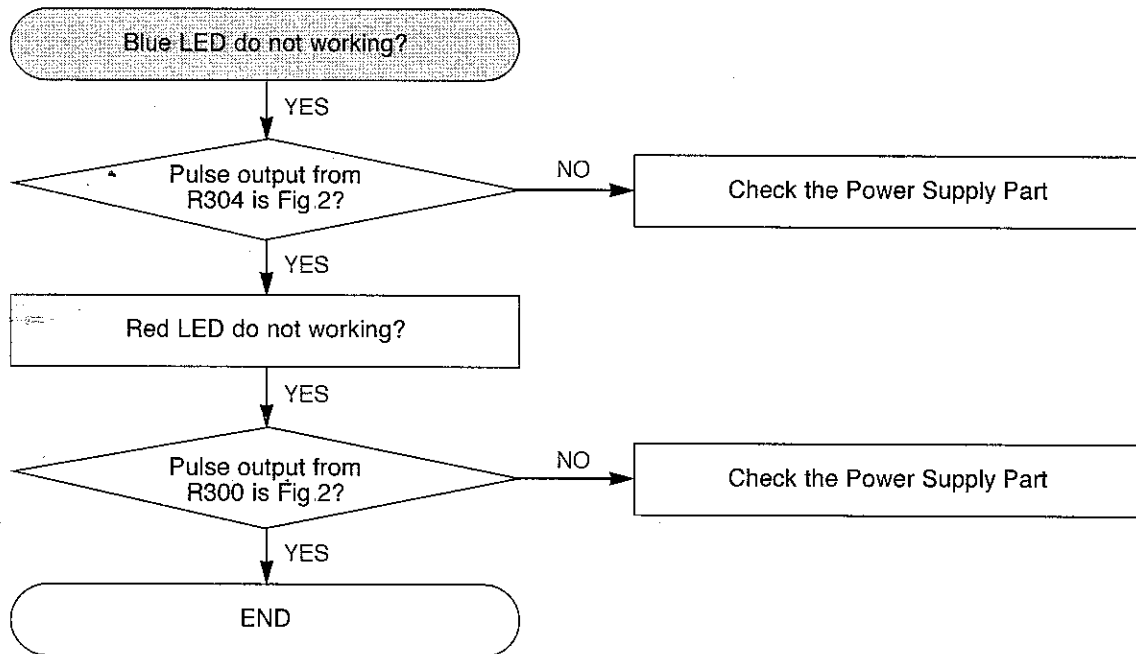
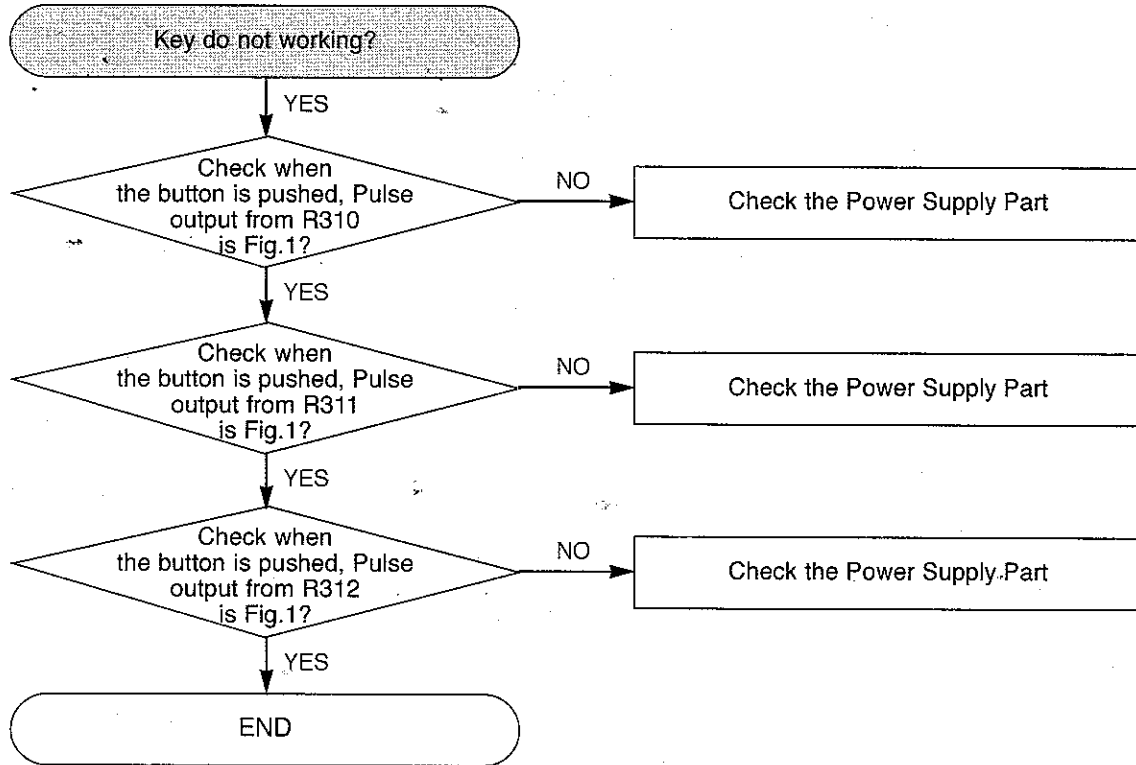

# ELECTRICAL TROUBLESHOOTING GUIDE & WAVEFORMS

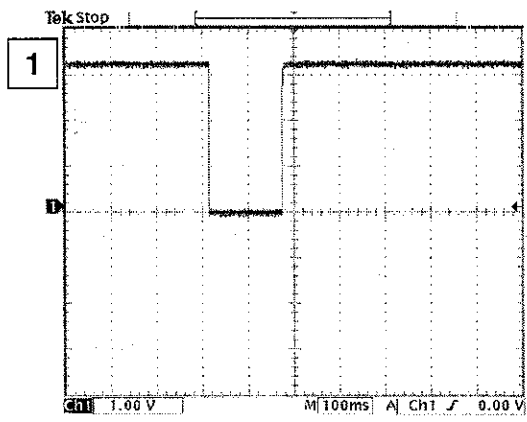
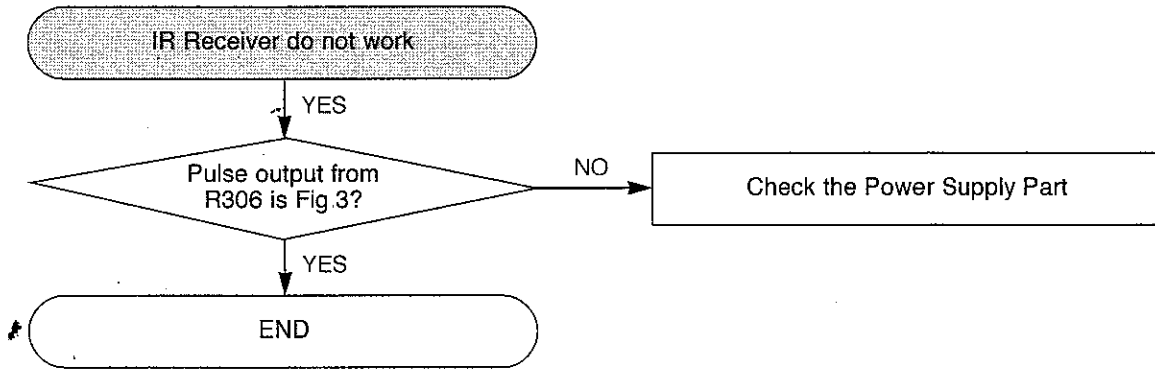

2 Oct 2007  
01:34:03

Fig.1 <Tact Switch pulse>

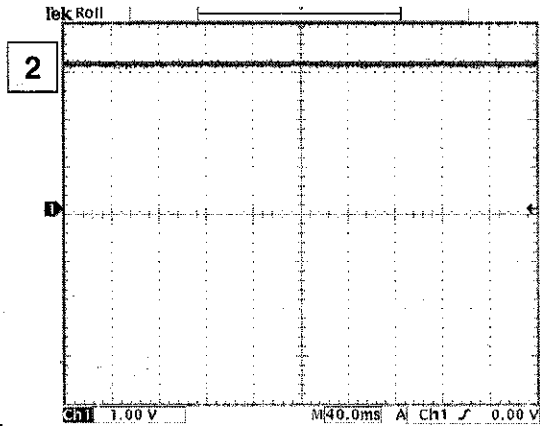

1 Oct 2007  
23:42:25

Fig.2 <LED pulse>

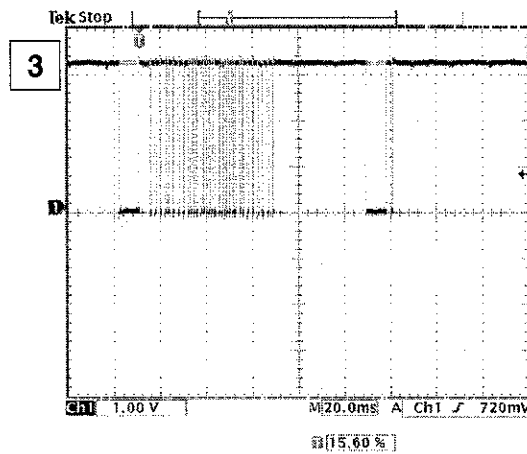

2 Oct 2007  
02:12:47

Fig.3 <IR receiver Pulse>

# ELECTRICAL TROUBLESHOOTING GUIDE & WAVEFORMS

## 3. RF FRONT-END PART (ATSC VSB)

3-1. If channel tune setup is fails and "No Signal" message is displayed.

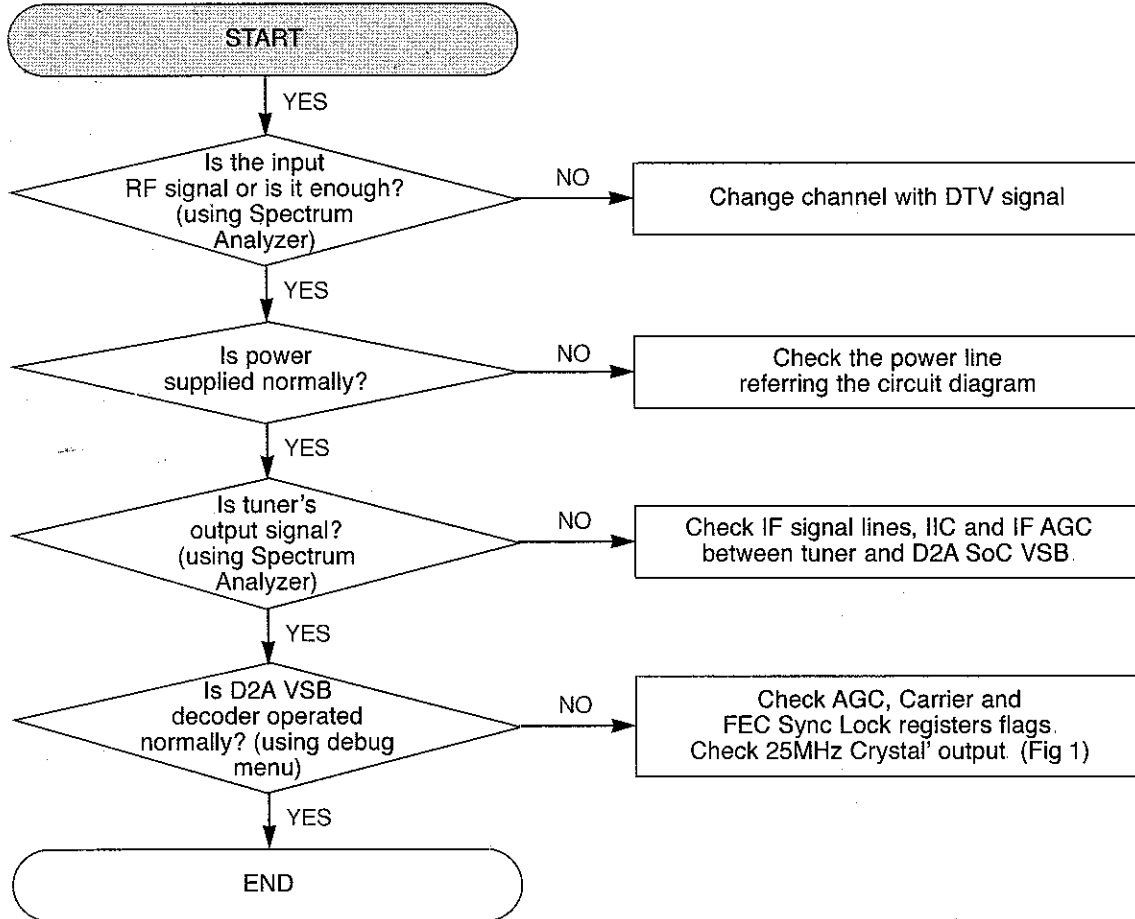

3-2. If tuner does not operate normally

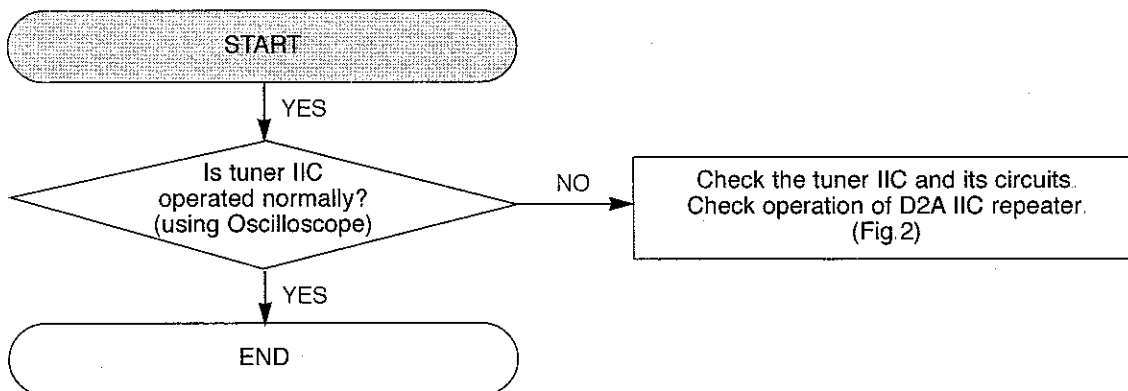

# ELECTRICAL TROUBLESHOOTING GUIDE & WAVEFORMS

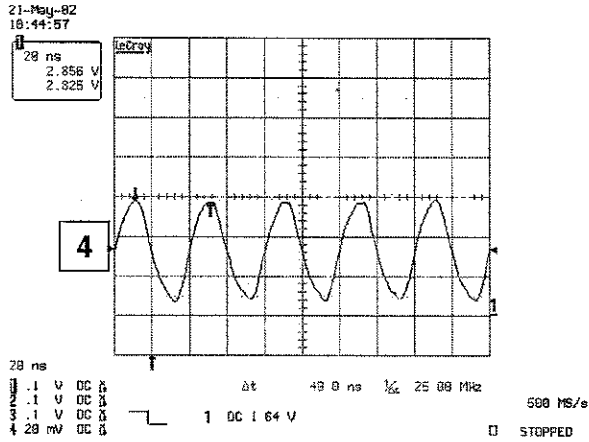

Fig.1

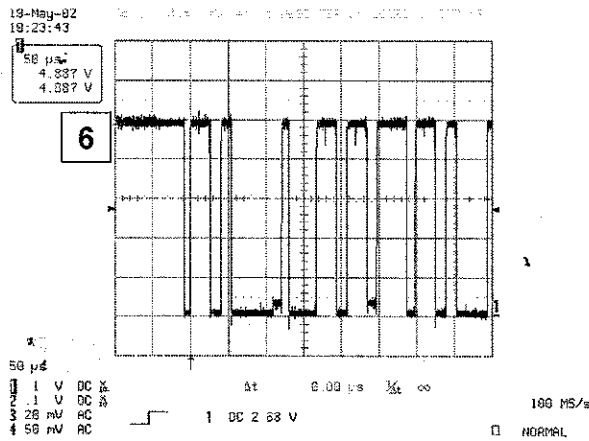
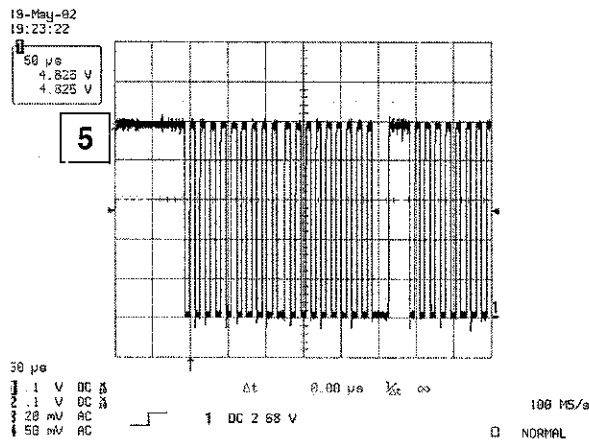
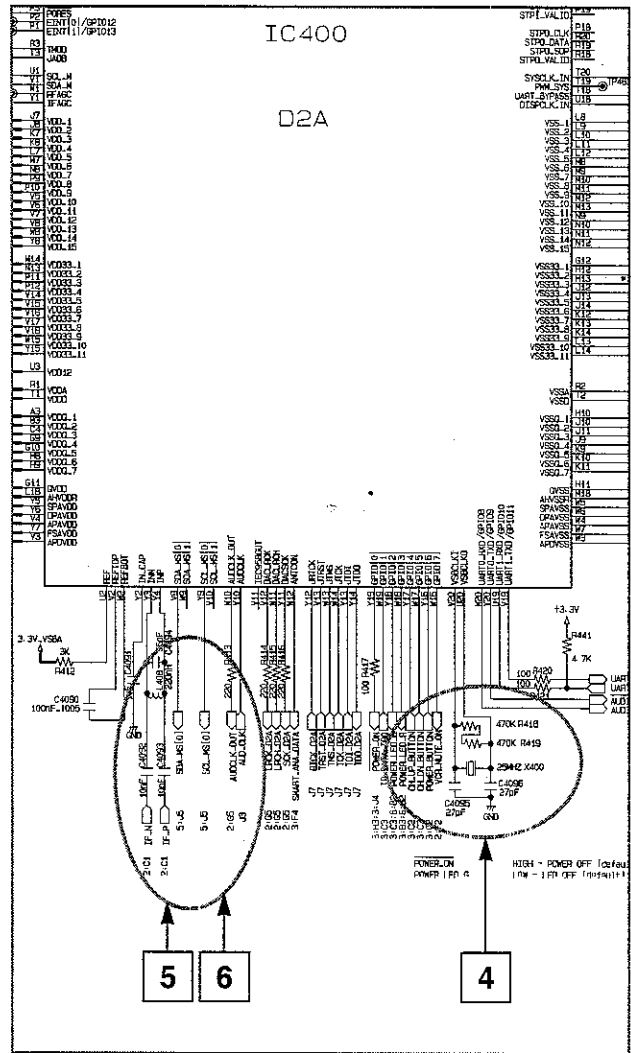
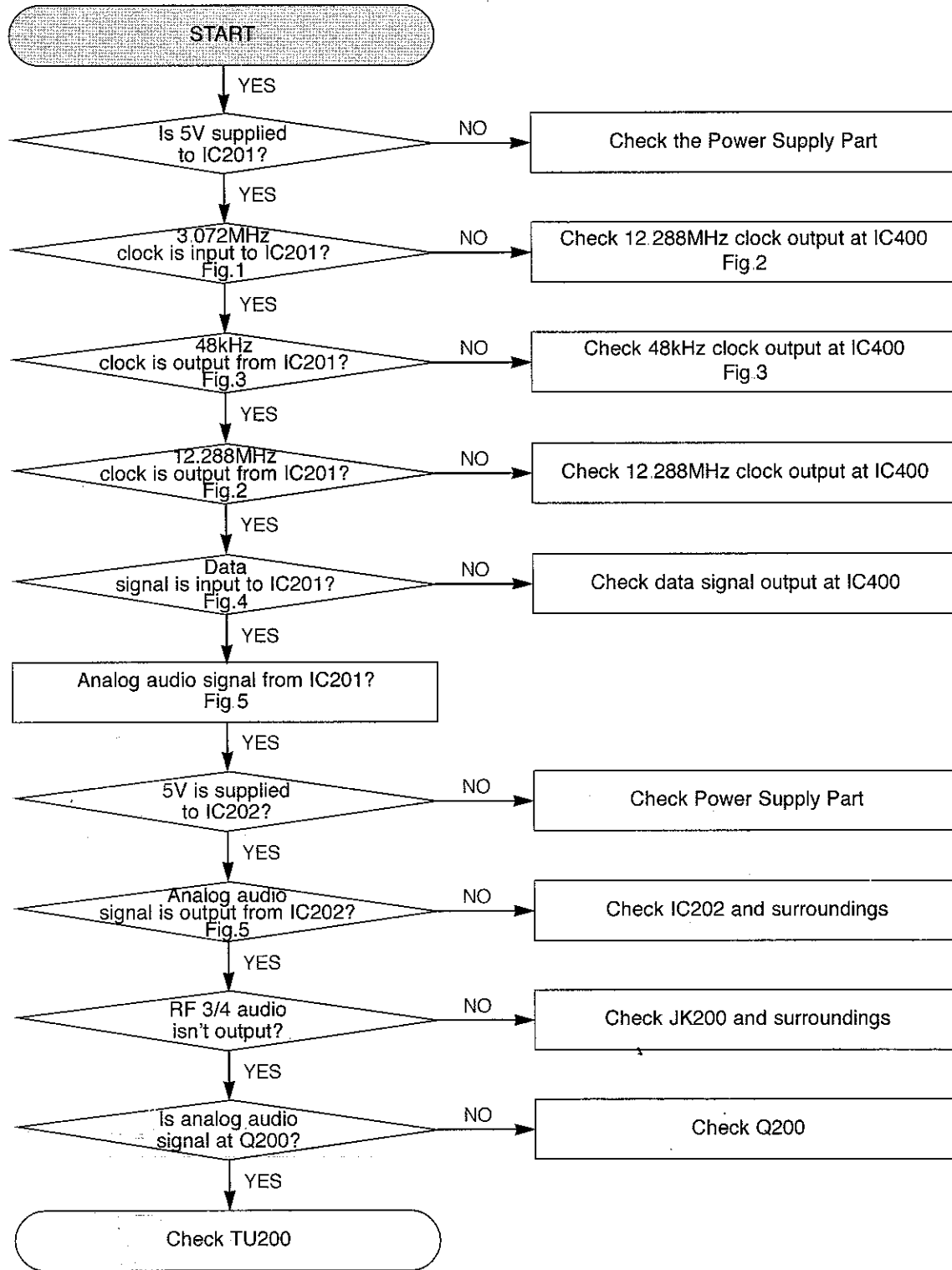

Fig.2



# ELECTRICAL TROUBLESHOOTING GUIDE & WAVEFORMS

## 4. AUDIO PART





# ELECTRICAL TROUBLESHOOTING GUIDE & WAVEFORMS

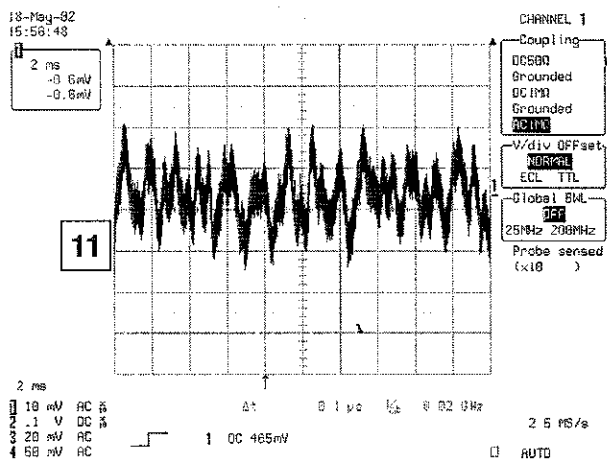
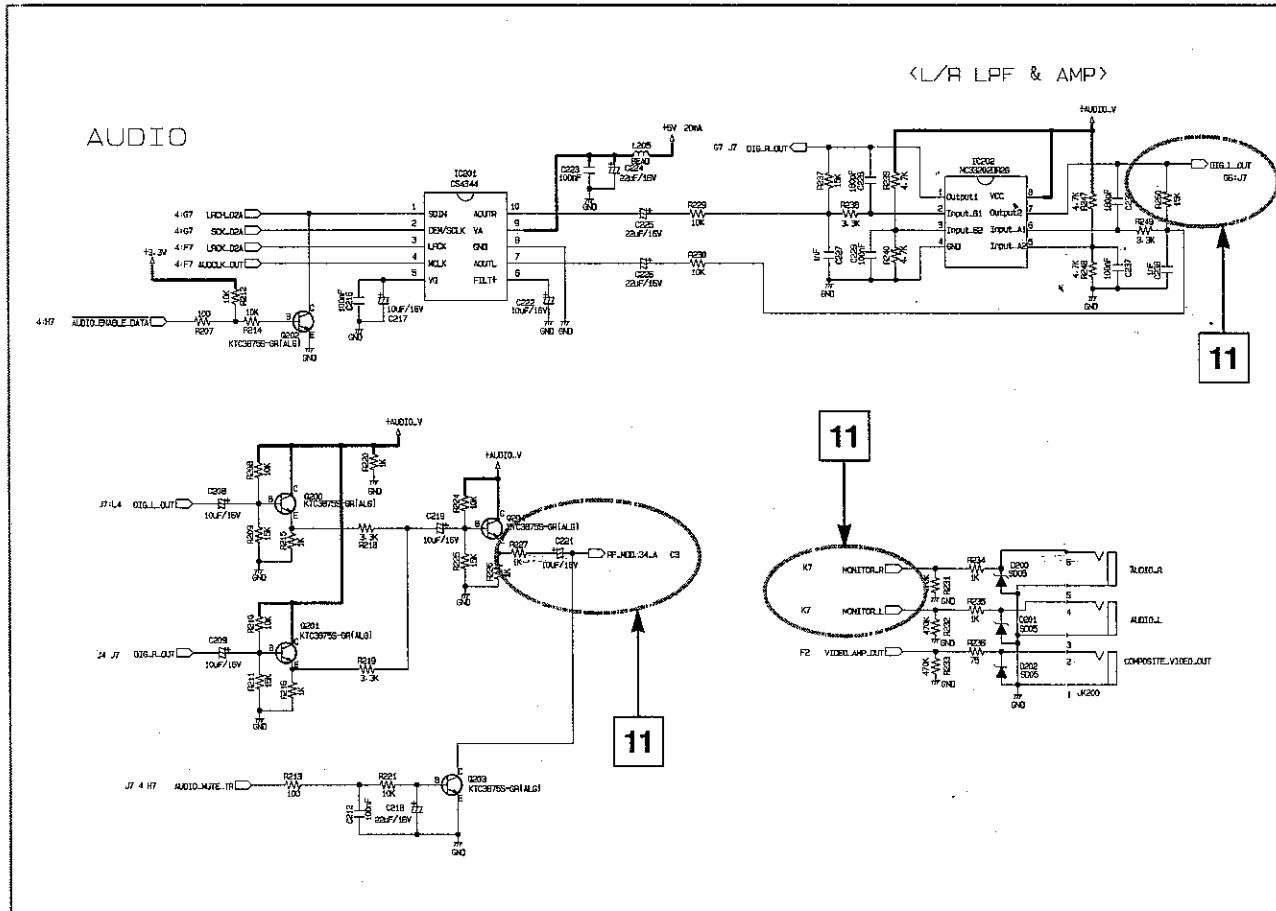
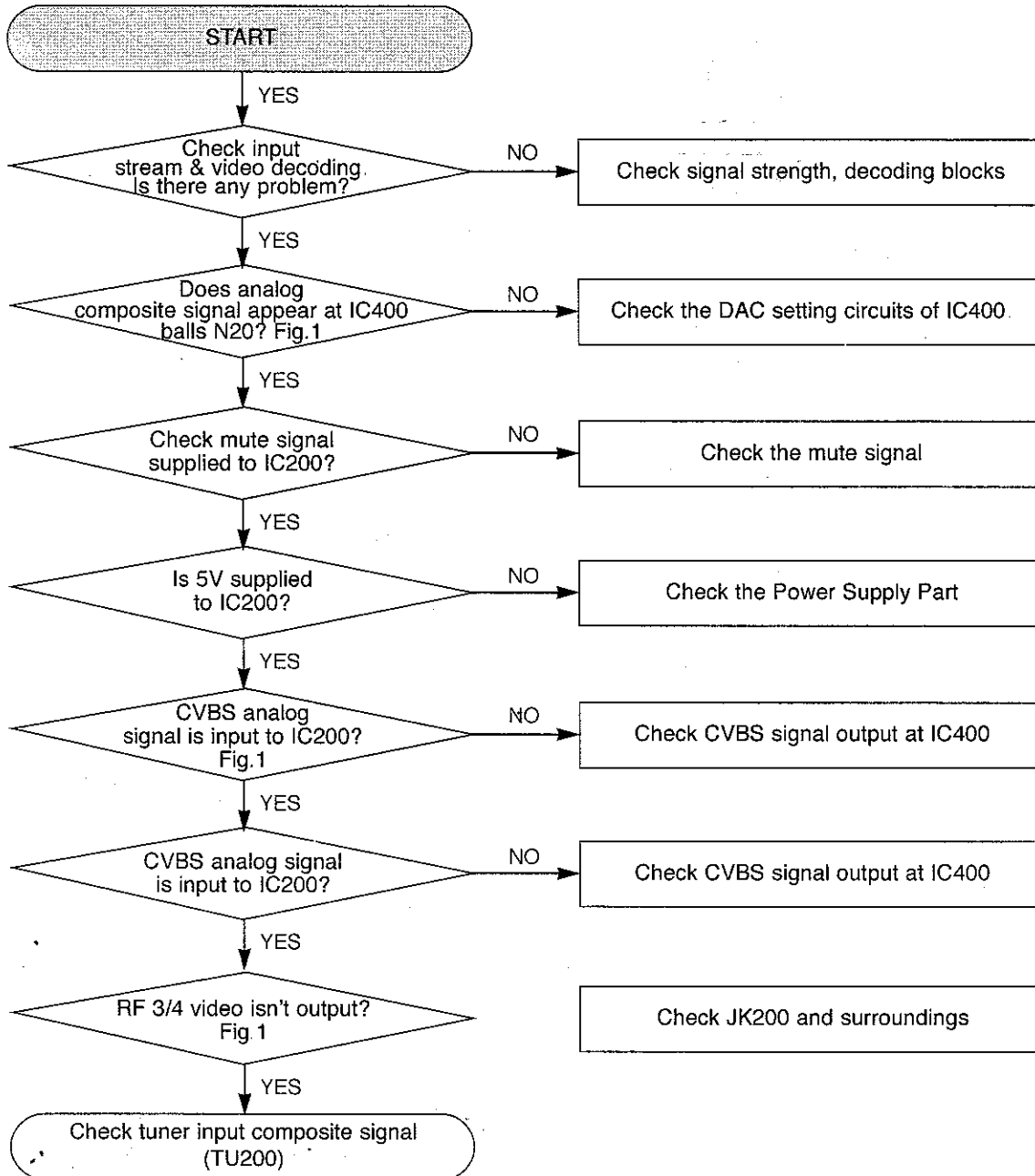

Fig.5

# ELECTRICAL TROUBLESHOOTING GUIDE & WAVEFORMS

## 5. VIDEO PART



# ELECTRICAL TROUBLESHOOTING GUIDE & WAVEFORMS

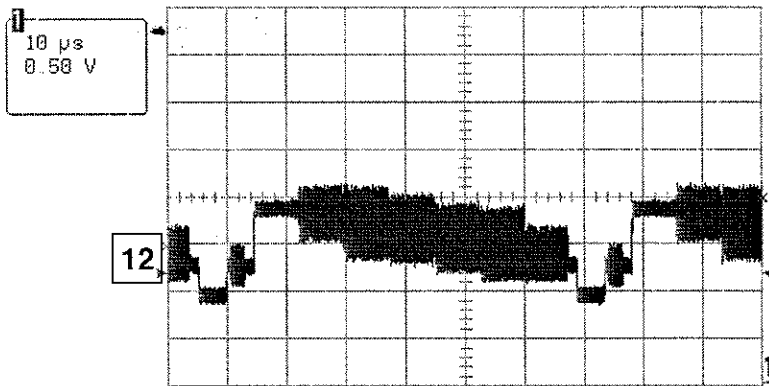
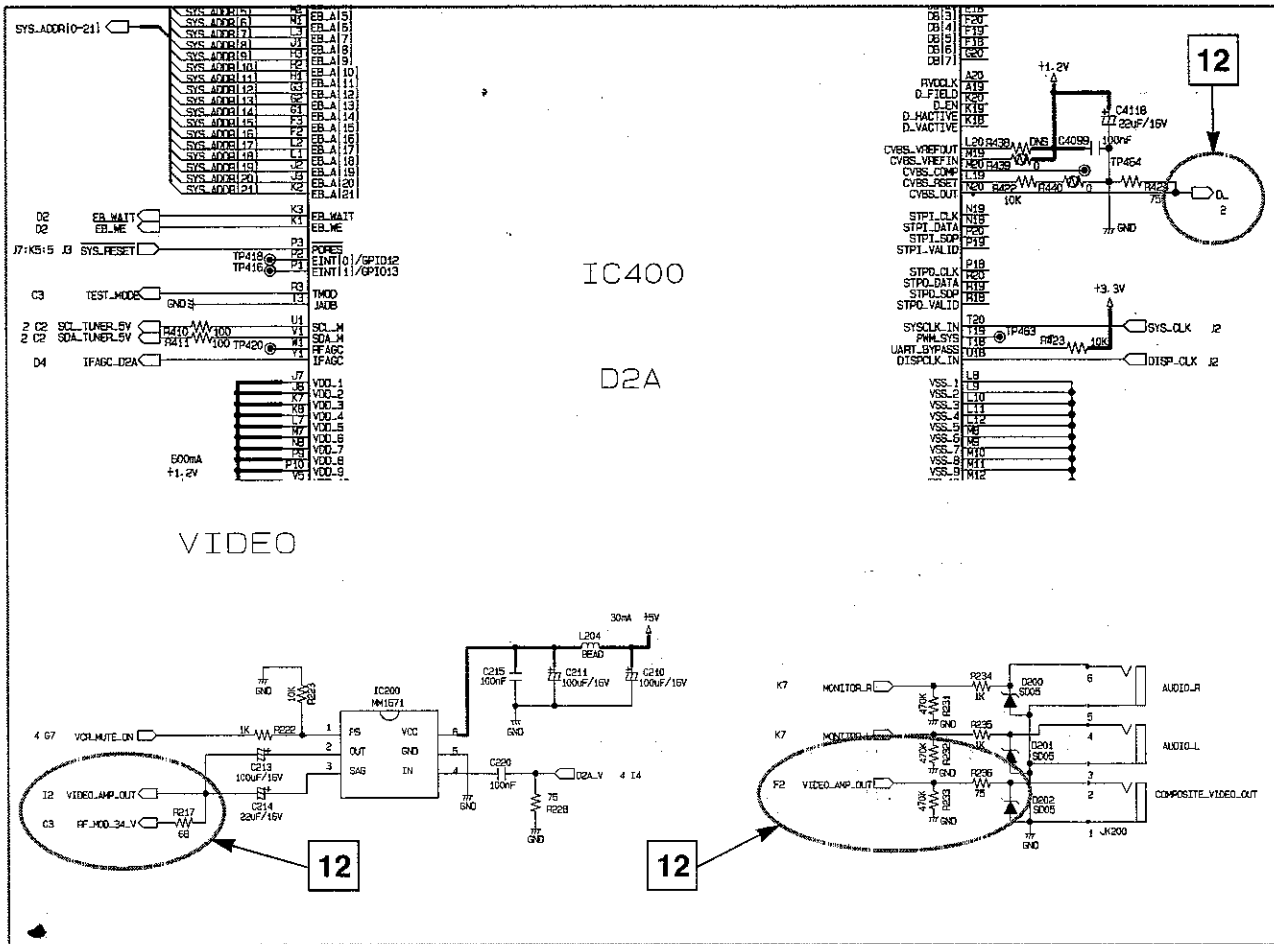
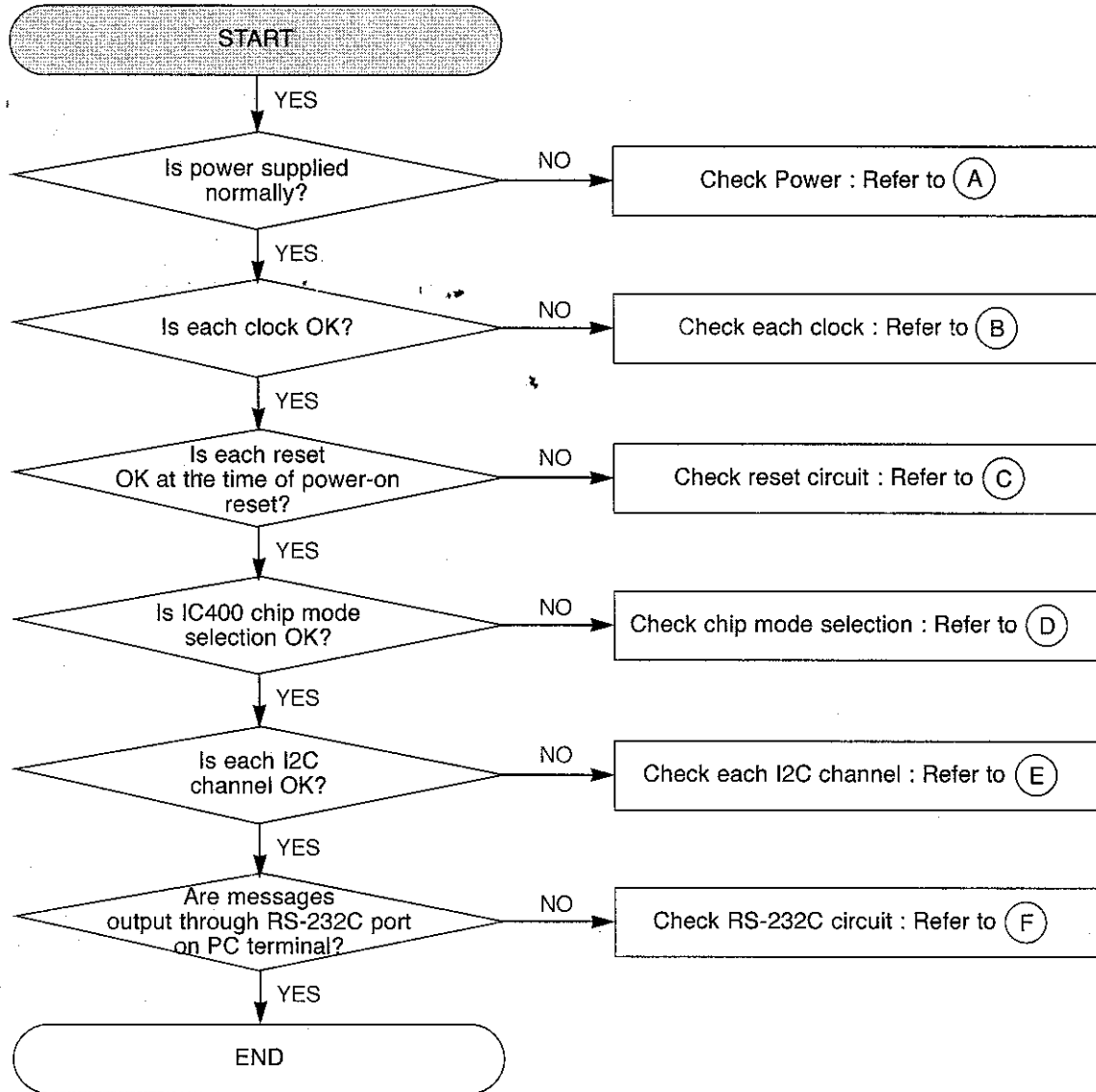

Fig.1

# ELECTRICAL TROUBLESHOOTING GUIDE & WAVEFORMS

## 6. SYSTEM (CPU) PART



# ELECTRICAL TROUBLESHOOTING GUIDE & WAVEFORMS

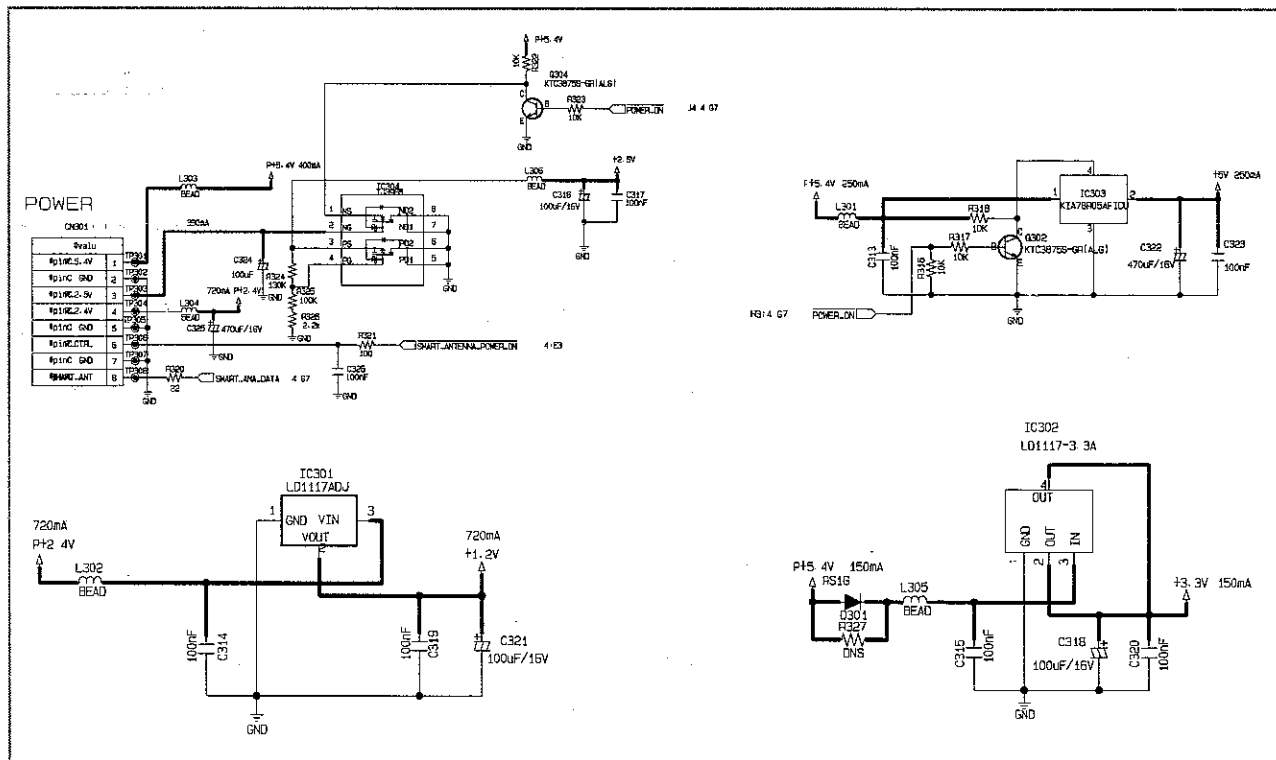
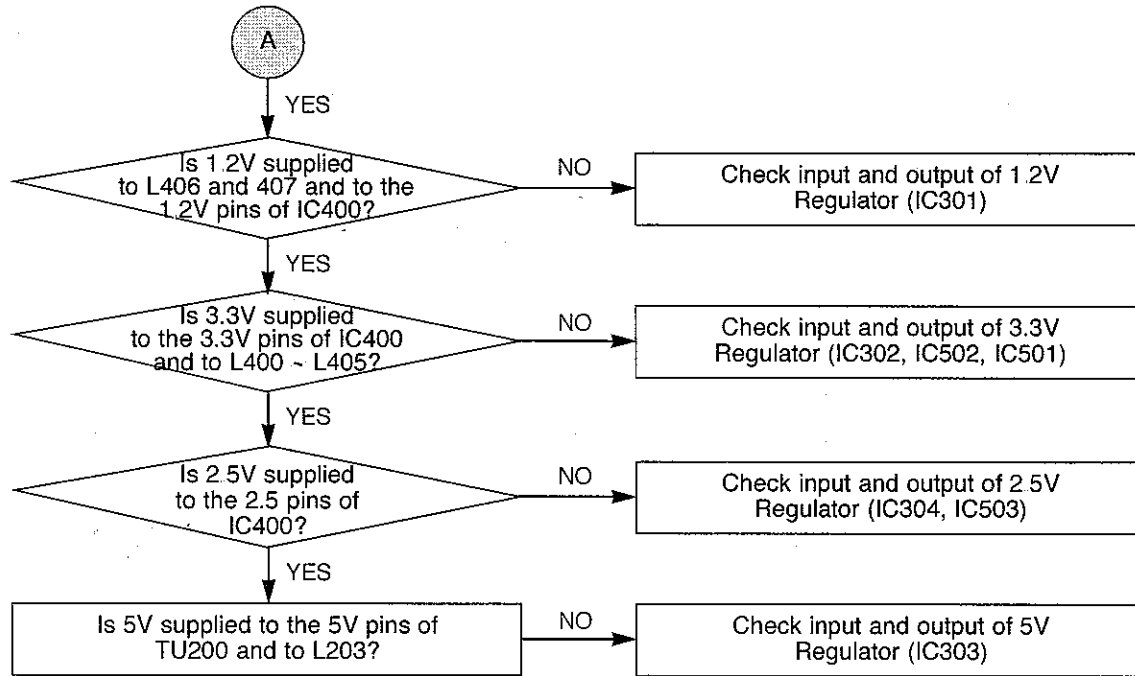

# ELECTRICAL TROUBLESHOOTING GUIDE & WAVEFORMS

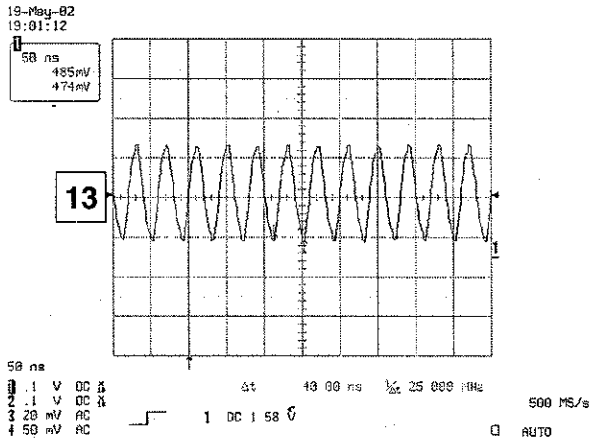
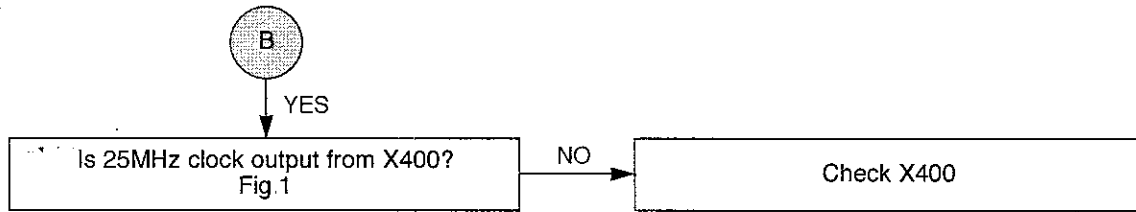

Fig.1

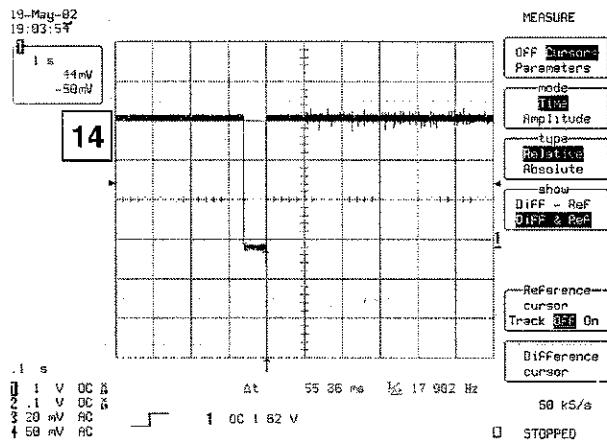
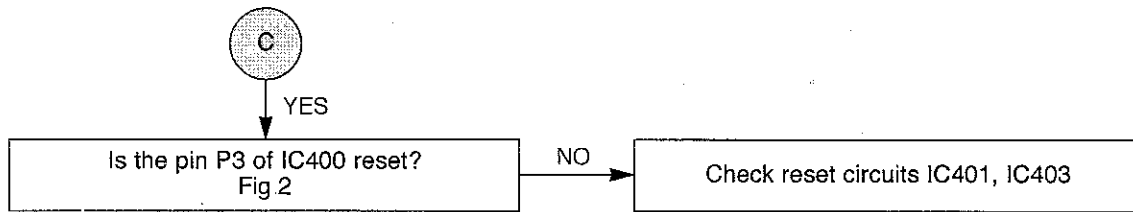
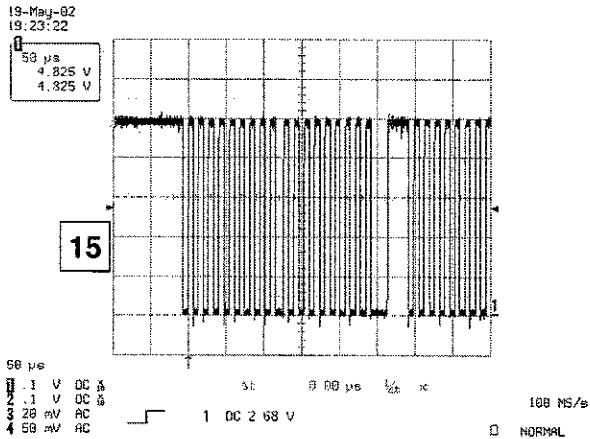
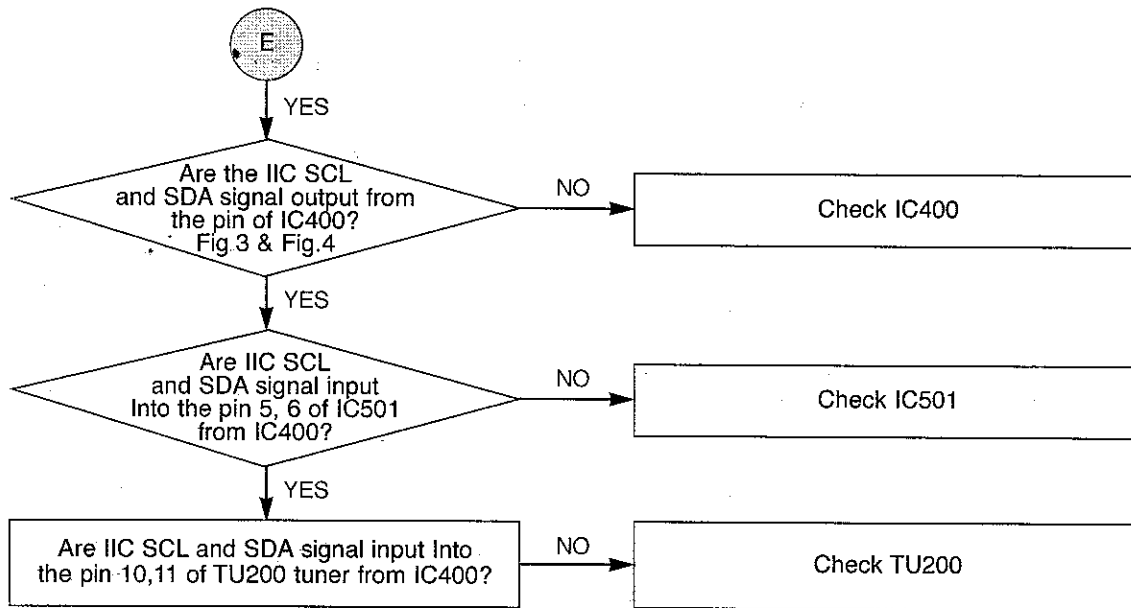
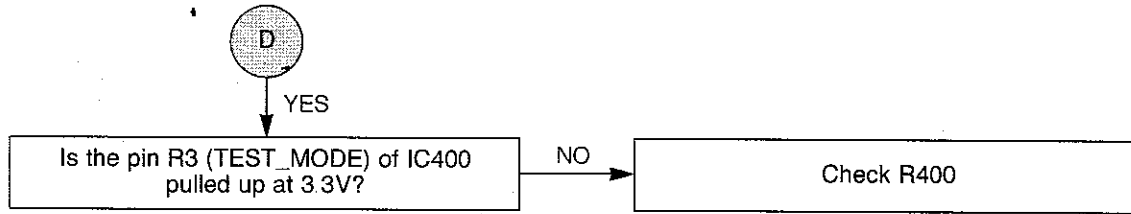
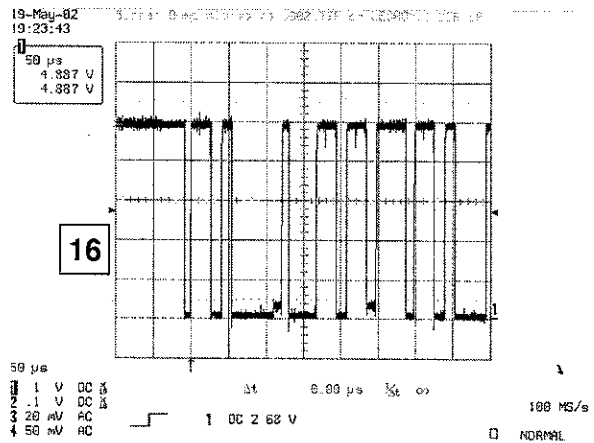

Fig.2

# ELECTRICAL TROUBLESHOOTING GUIDE & WAVEFORMS



**Fig.3**



**Fig.4**

# ELECTRICAL TROUBLESHOOTING GUIDE & WAVEFORMS

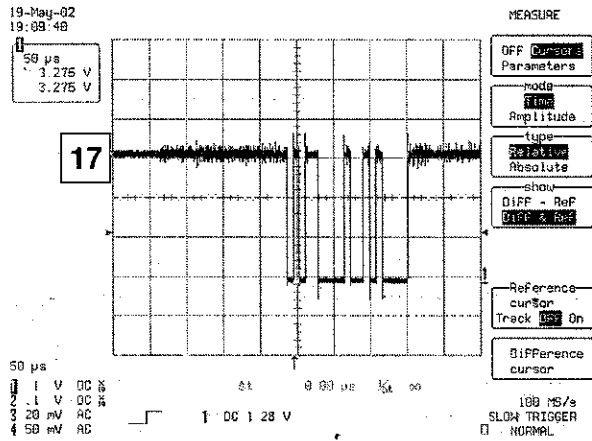
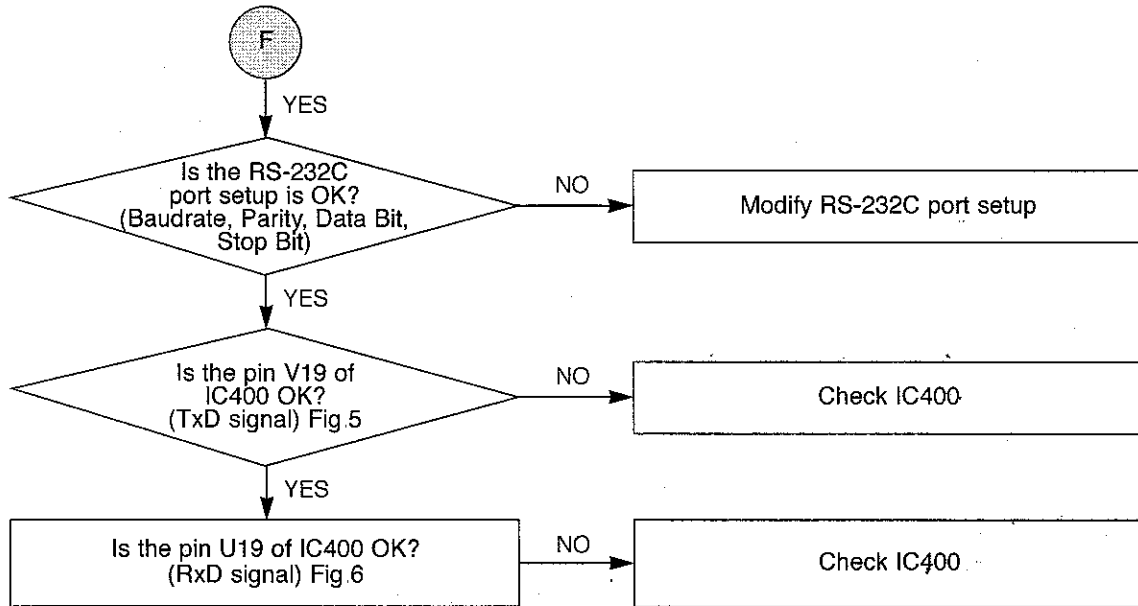

Fig.5

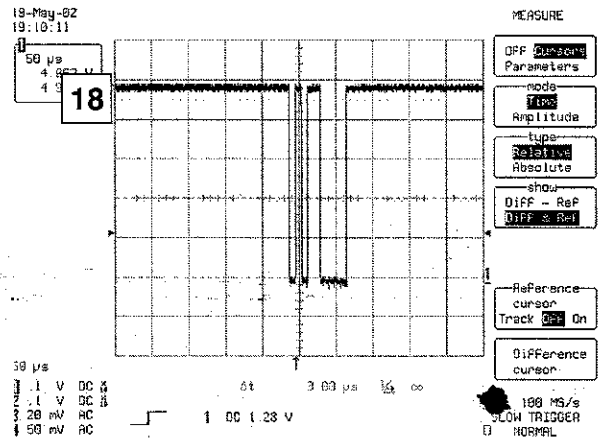
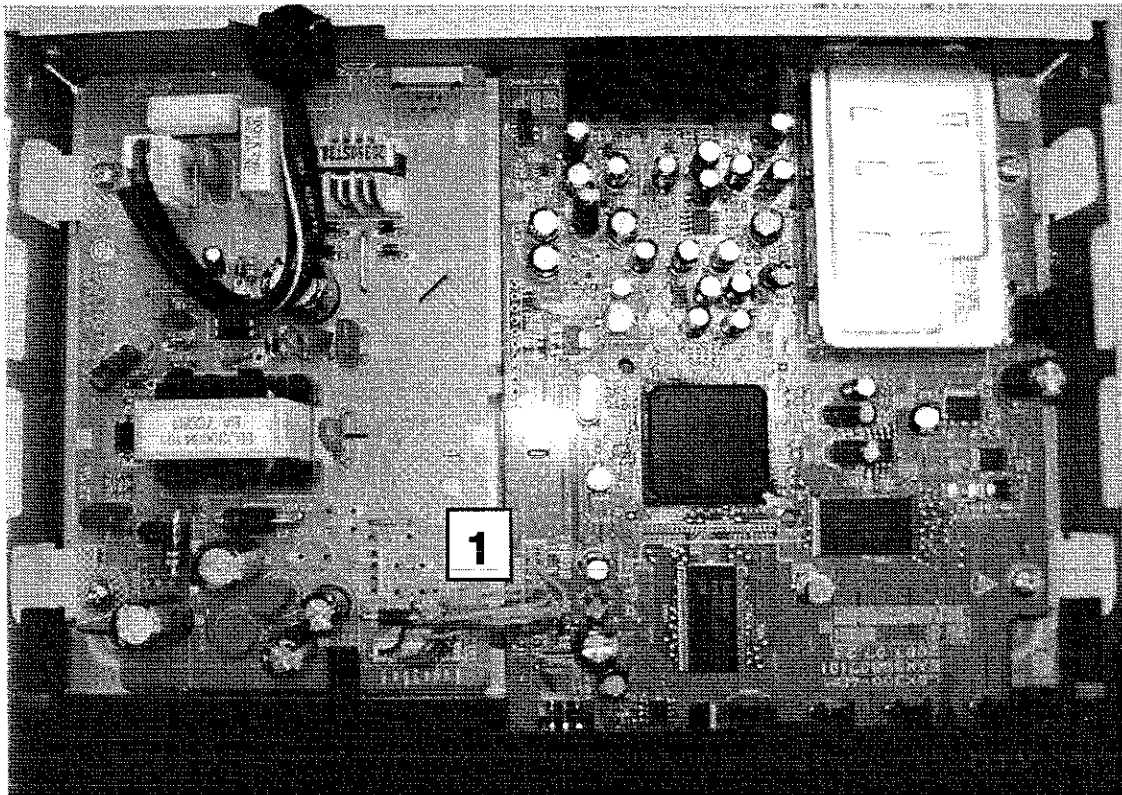
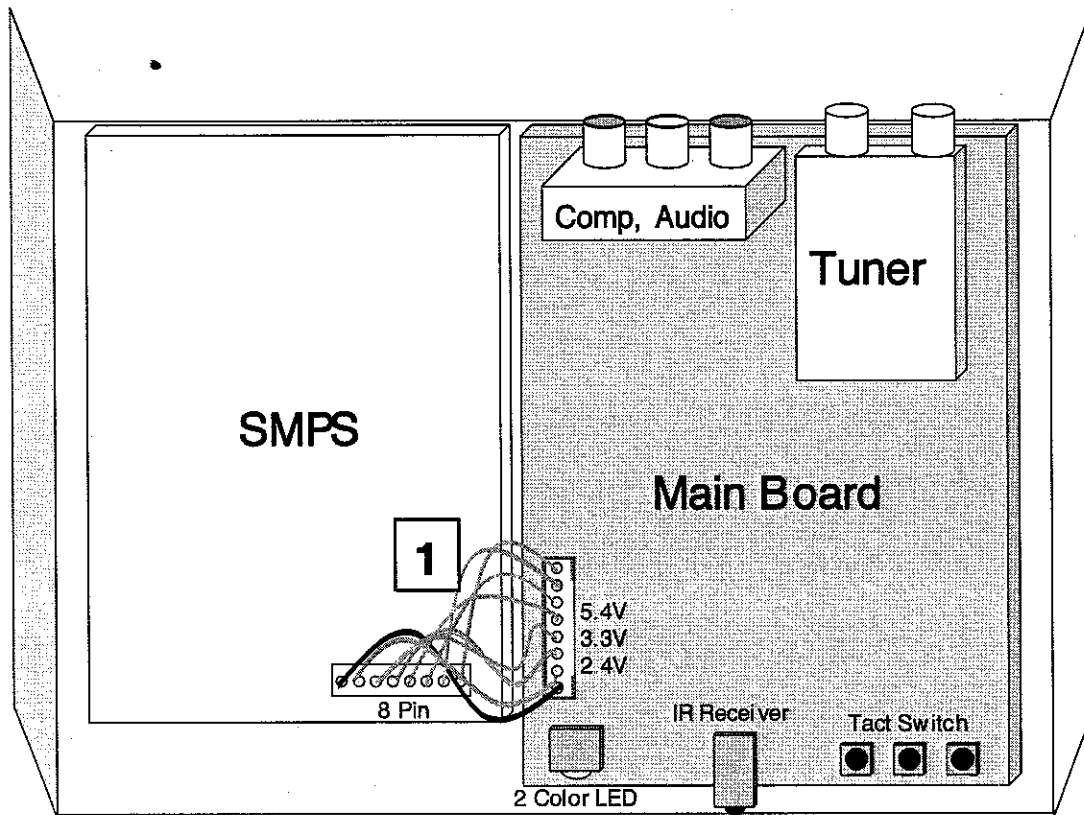

Fig.6

# WIRING DIAGRAM



# BLOCK DIAGRAMS

## 1. POWER (SMPS) BLOCK DIAGRAM

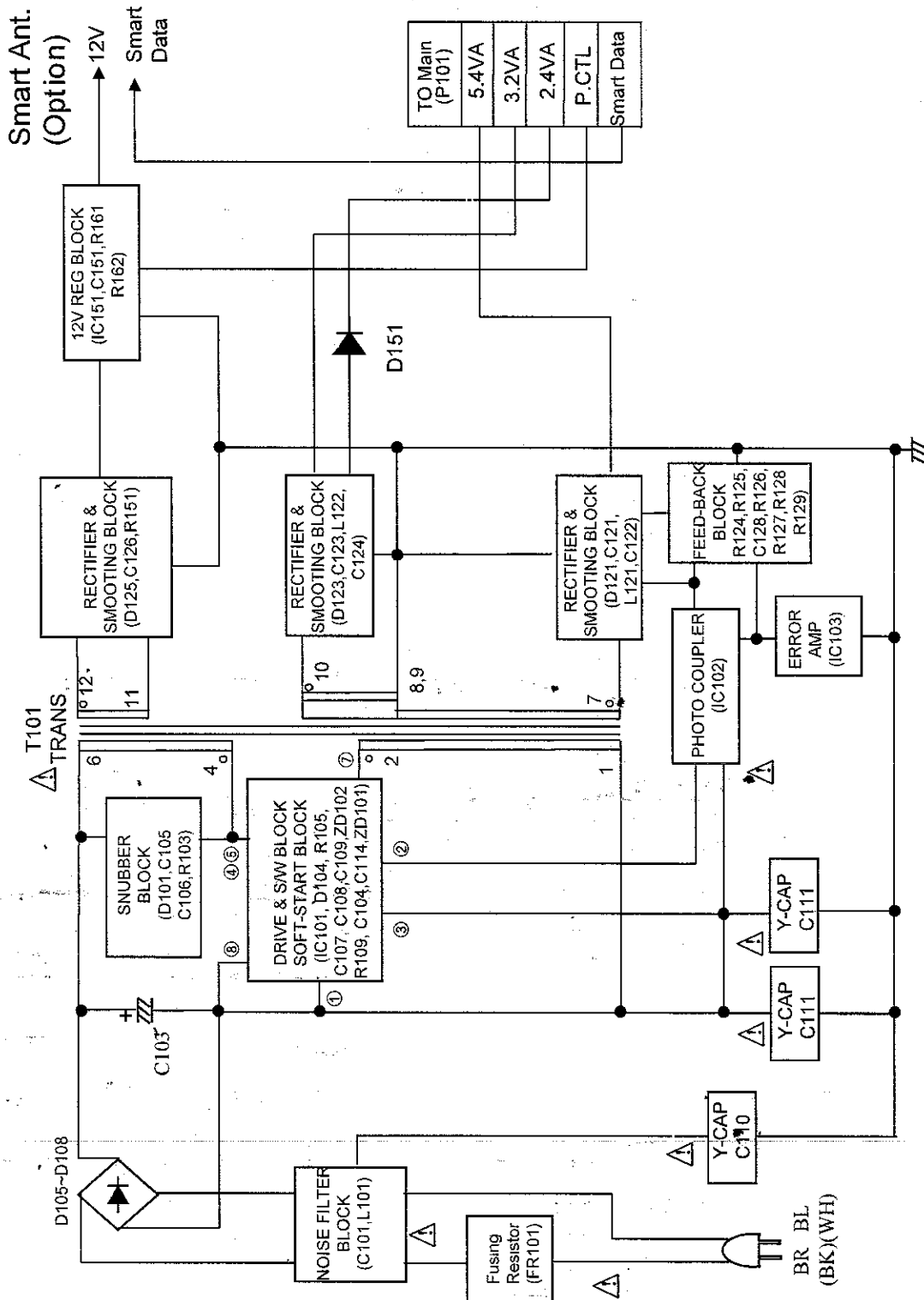

## 2. OVERALL BLOCK DIAGRAM

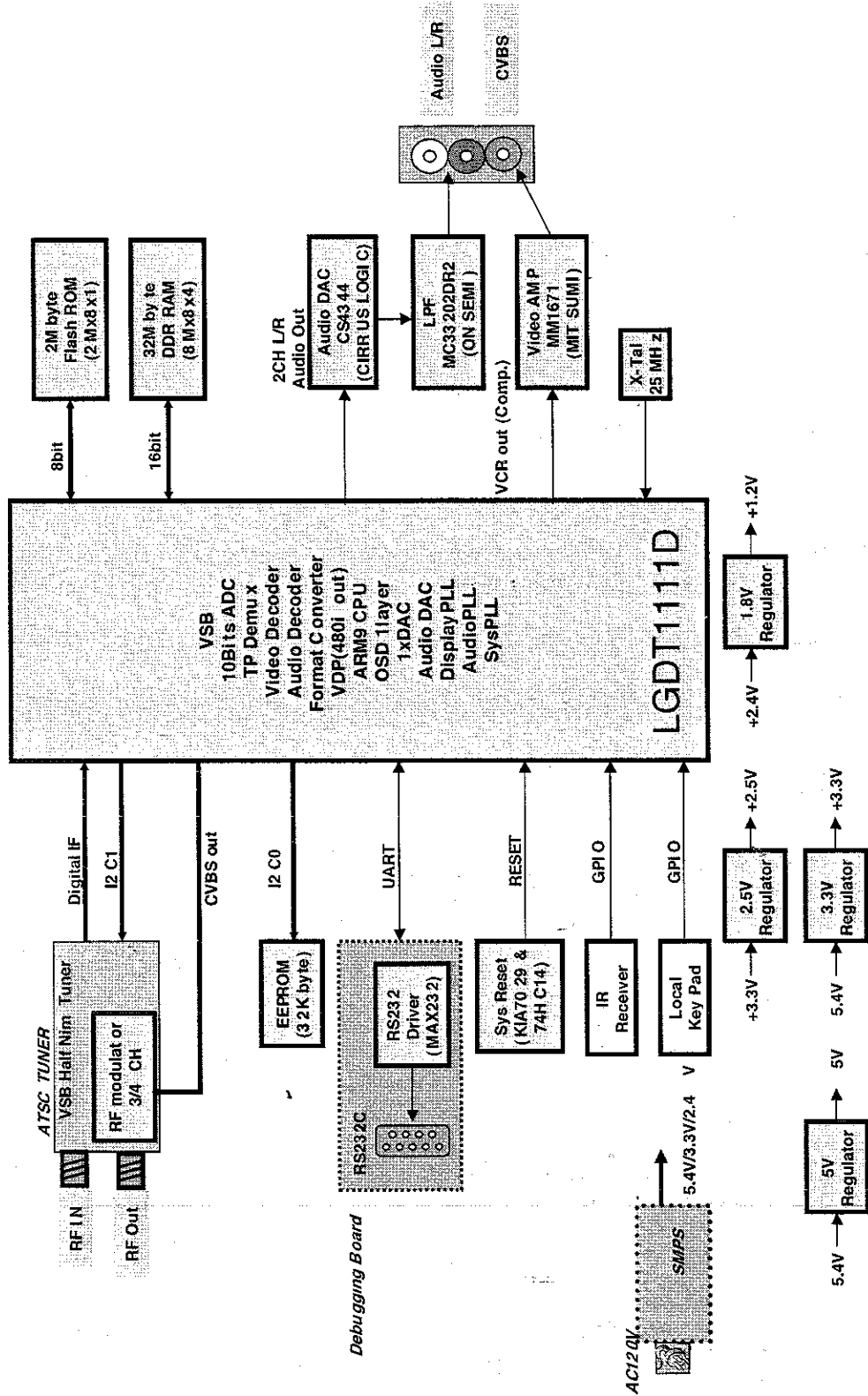



## 2. ANALOG CIRCUIT DIAGRAM

TUNER

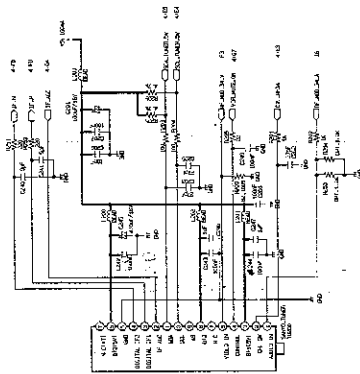

VIDEO

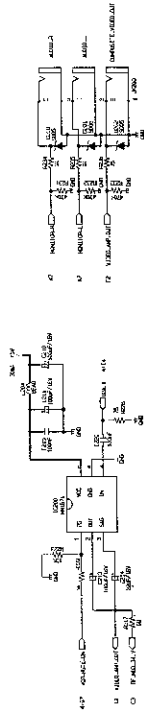

RESISTOR VALUE  
 100Ω 10k 100k 1M  
 CAPACITOR VALUE  
 100pF 1nF 10nF 100nF 1μF

(L/R-LPF & AMP)

AUDIO

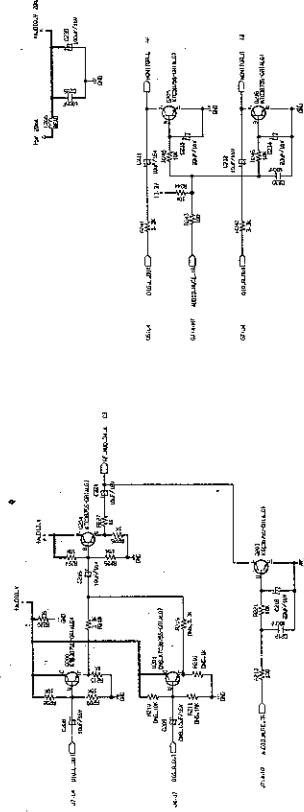
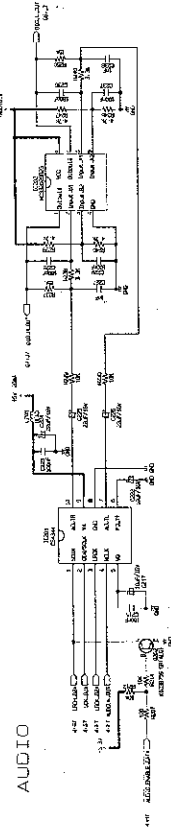

LSX300...4DM ANALOG  
 ESY39B07301 2/6  
 2007/10/08



# 4. SYSTEM CIRCUIT DIAGRAM

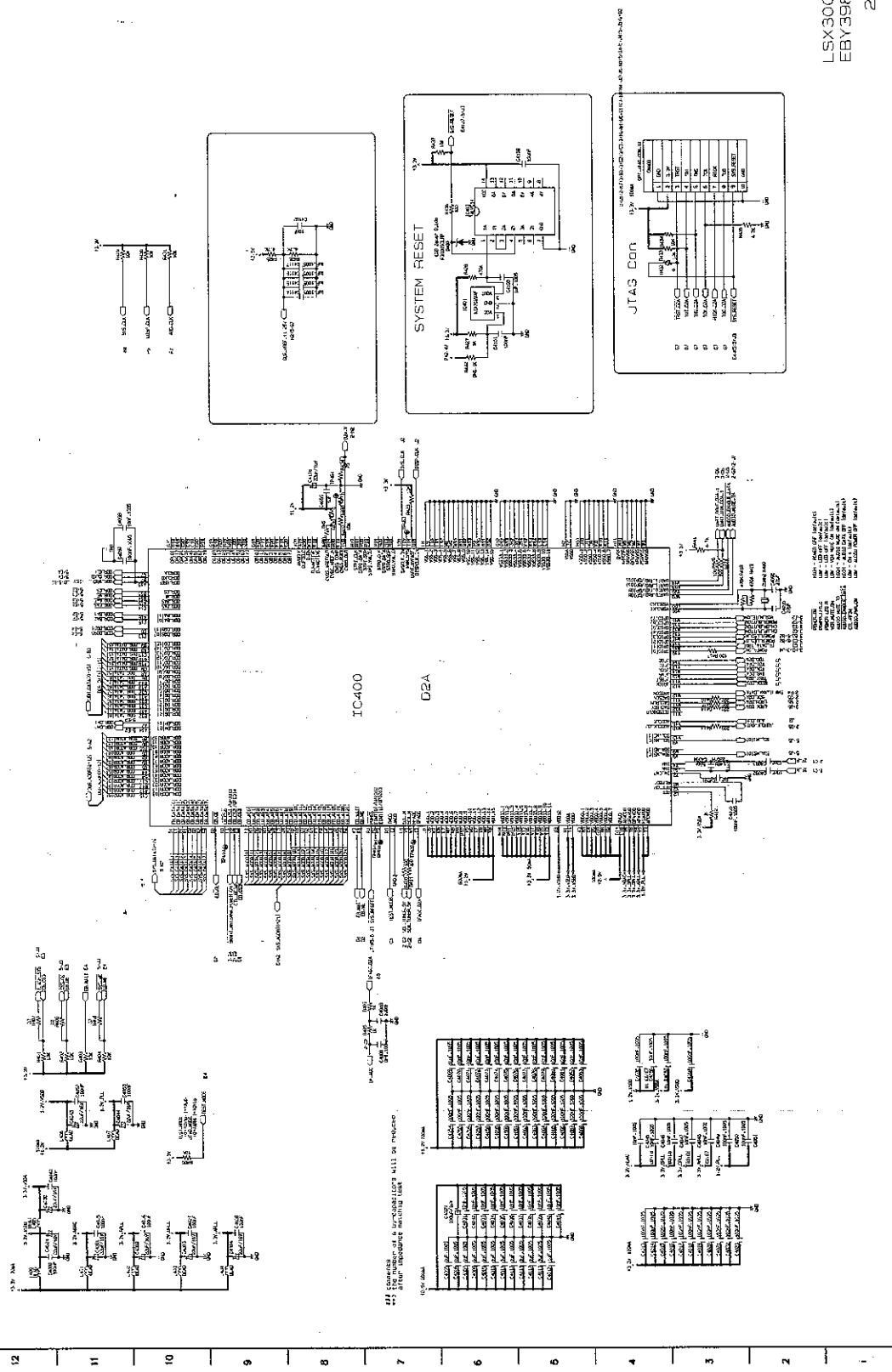

LSX300-4DM SYSTEM  
 EBY3960730.1 4/5  
 2007/10/08

A B C D E F G H I J K L M N O P Q R S T



6. FRONT PANEL CIRCUIT DIAGRAM

FRONT PANEL BOARD

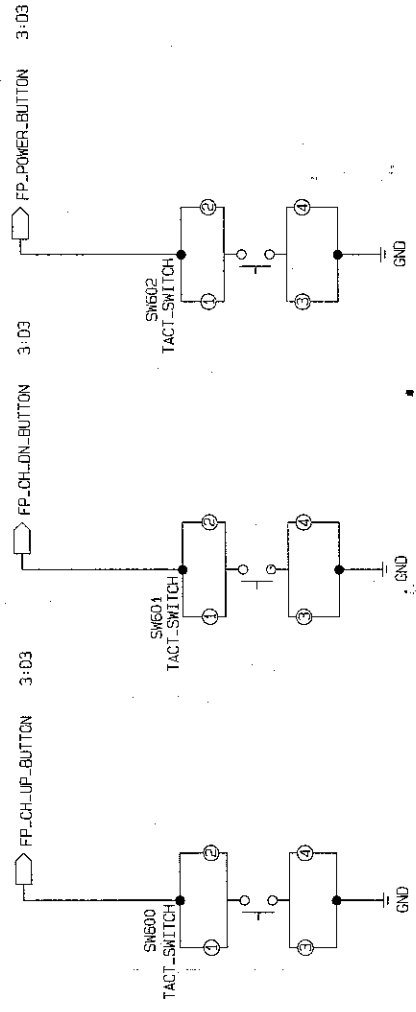
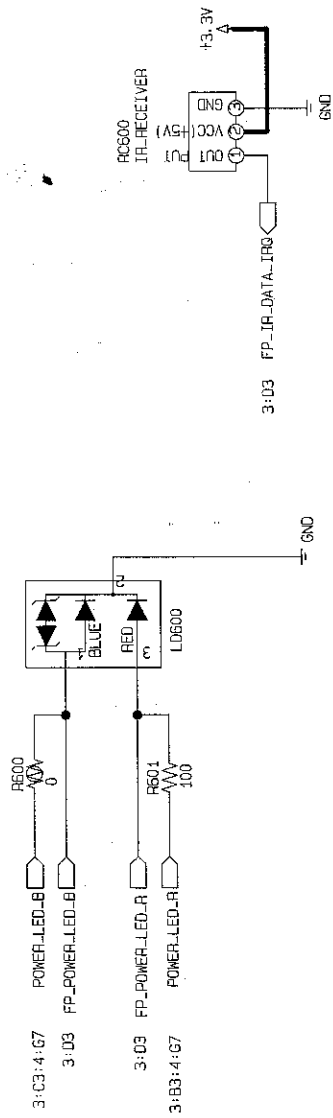

LSX300-40M FRONT PANEL  
 EBY39807301 B/6  
 07/10/08

**PRINTED CIRCUIT BOARD DIAGRAMS**

**1. MAIN P.C. BOARD**

(TOP VIEW)

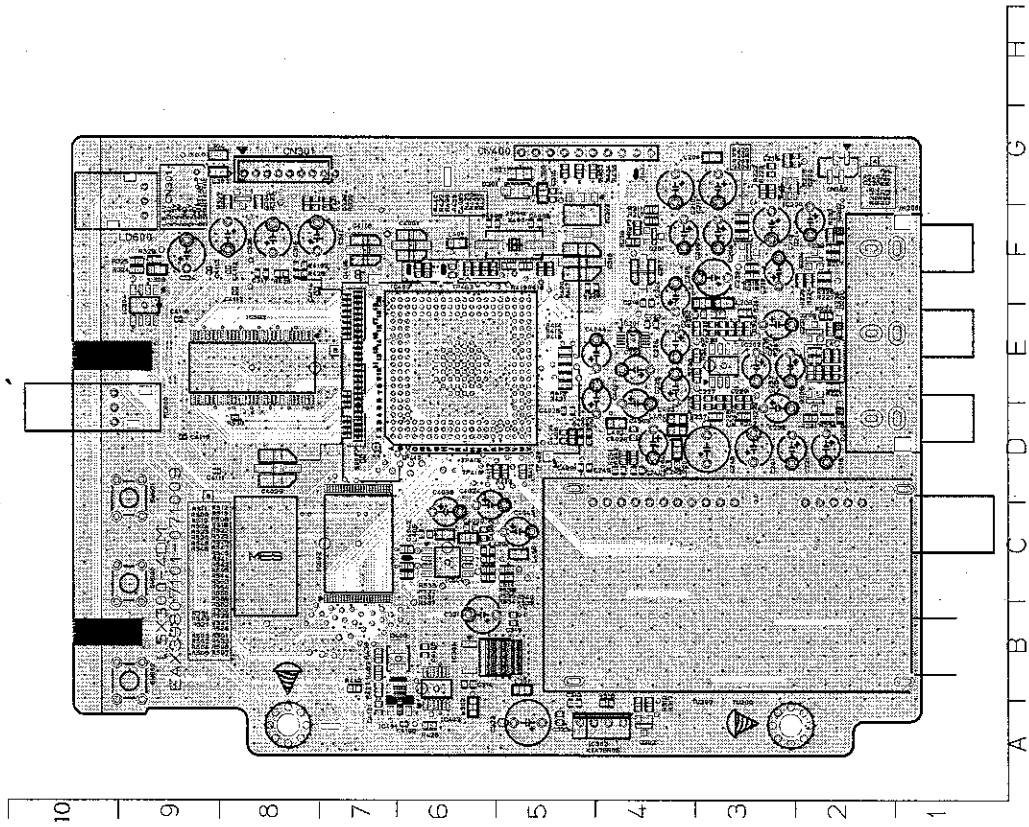

(BOTTOM VIEW)

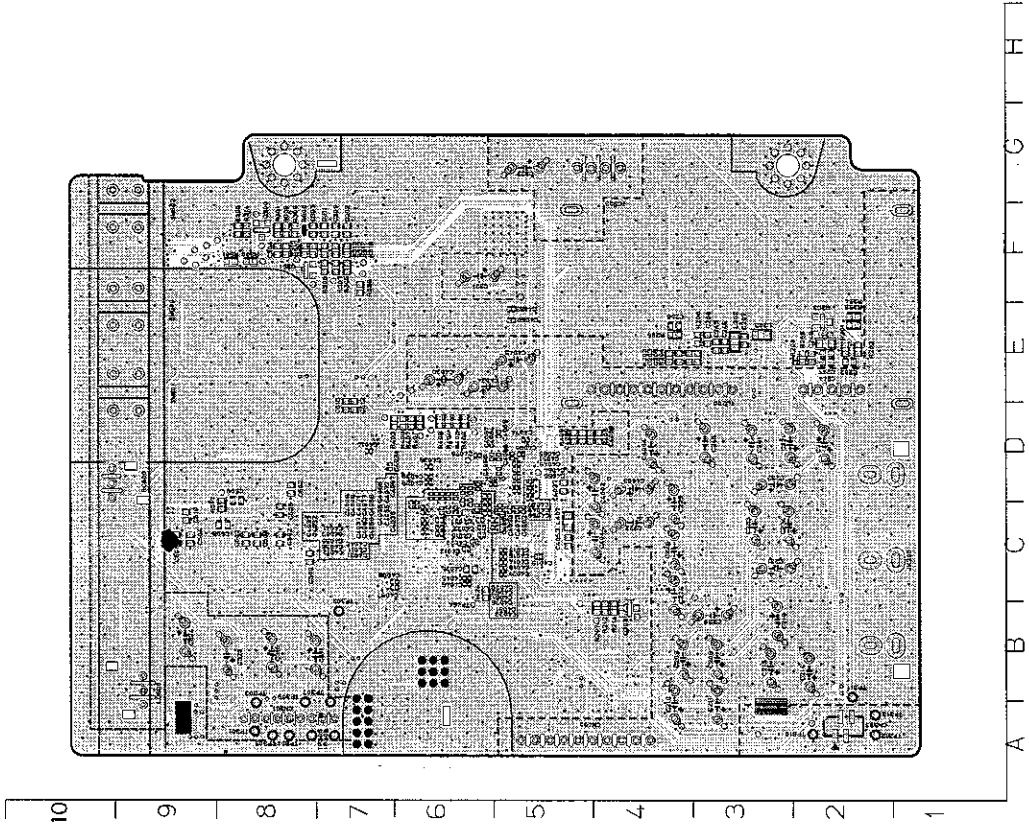

**2. POWER (SMPS) P.C. BOARD  
(TOP VIEW)**

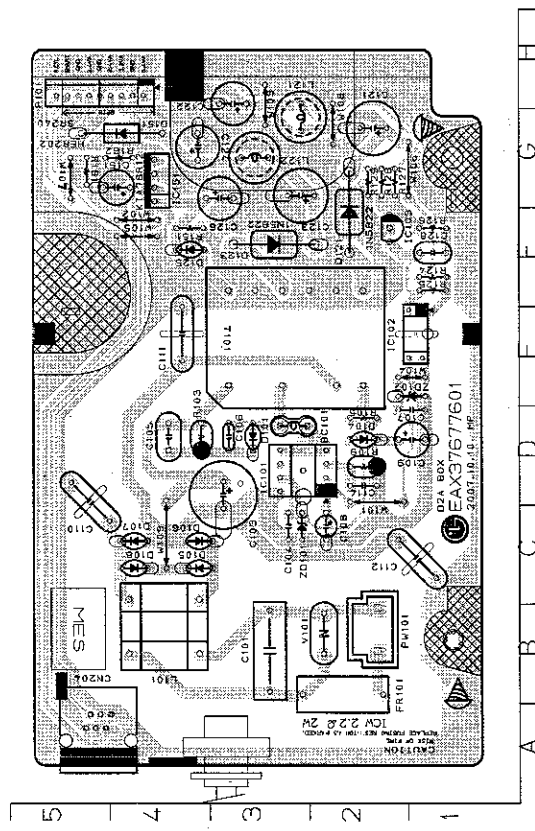

**(BOTTOM VIEW)**

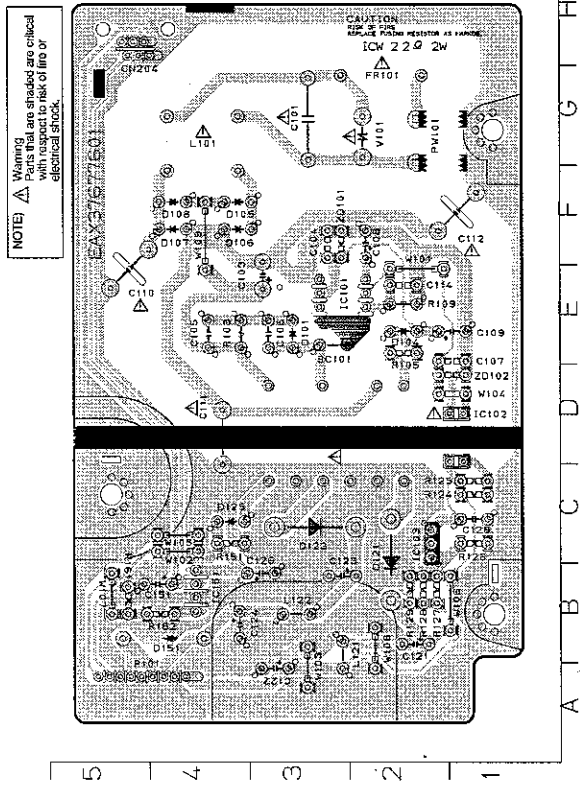



S	AL	LOCA. NO.	PART NO.	DESCRIPTION	SPECIFICATION	REMARKS
		D106	ODRGF00309A	Diode,Rectifier	1A5 600V 1.1V 1A 25A 1NSEC R1	
		D106	ODRRE00203A	Diode,Rectifier	1A7 600V 1.1V 5UA 25A - R1 TP	ALTERNATE
		D107	ODRGF00309A	Diode,Rectifier	1A5 600V 1.1V 1A 25A 1NSEC R1	
		D107	ODRRE00203A	Diode,Rectifier	1A7 600V 1.1V 5UA 25A - R1 TP	ALTERNATE
		D108	ODRGF00309A	Diode,Rectifier	1A5 600V 1.1V 1A 25A 1NSEC R1	
		D108	ODRRE00203A	Diode,Rectifier	1A7 600V 1.1V 5UA 25A - R1 TP	ALTERNATE
		D121	ODR158220AA	Diode,Schottky	1N5822 950MV 40V 3A 1NSEC 250p	
		D121	ODRGF00210A	Diode,Rectifier	1N5822 40V 950MV 2MA 80A 1NSEC	ALTERNATE
		D123	ODR158220AA	Diode,Schottky	1N5822 950MV 40V 3A 1NSEC 250p	
		D123	ODRGF00210A	Diode,Rectifier	1N5822 40V 950MV 2MA 80A 1NSEC	ALTERNATE
		D151	ODR202000AB	Diode,Rectifier	HER202 100V 1V 5UA 60A 50NSEC	
		D151	ODSTW00070A	Diode,Rectifier	HER202-TSC 100V 1V 5UA 60A 50N	ALTERNATE
		FR101	ORM0221K634	Resistor,Cement	RWR02V-J2R20 2.2OHM 5% 2W 27X1	
		IC101	0IPMGIH005C	IC,PWM Controller	ICE3B0365J MAX27V ADJ 10W DIP	
		IC102	657-083A	Sensor,Position	LTV-817B 5V DIP BK PHOTO COUPL	
		IC102	8500RDB011B	Sensor,Position	K1010B 5V DIP BK 4PIN PHOTOCO	ALTERNATE
		IC103	0IKE431000A	IC,Voltage Regulator	KIA431 36V 36V 700MW T092 TP 3	
		IC103	0ISS431000A	IC,Voltage Regulator	KIA431AZ 2.495TO36V 36V 770MW T	ALTERNATE
		IC103	0IPMGUC004B	IC,LDO Voltage Regulator	TL431 MAX12V 3.3V - T092 TP 3P	ALTERNATE
		L101	6200JB80130	Filter,Line Noise	CHE-80130 35MH 19.5X17X22MM R7	
		L121	633-088G	Coil,Choke	22KS 22uH -- 8X17MM LEAD - K	
		L121	6200J000147	Inductor,Wire Wound,Radial	LPL0813T-220K. 22UH 10% 0V 1.7	ALTERNATE
		L121	6140R-C011A	Coil,RF	6140R-C011A 22uH -- 8X17MM LE	ALTERNATE
		L122	633-088G	Coil,Choke	22KS 22uH -- 8X17MM LEAD - K	
		L122	6200J000147	Inductor,Wire Wound,Radial	LPL0813T-220K. 22UH 10% 0V 1.7	ALTERNATE
		L122	6140R-C011A	Coil,RF	6140R-C011A 22uH -- 8X17MM LE	ALTERNATE
		P101	6631R-E078S	Harness,Single	8P-60MM (LSX300) GIL-S-8 9073-	
		PW101	561-292B	Connector,Wafer	GP390-03P-TS 3P 3.96MM 1R STRA	
		R103	0RS1003K619	Resistor,Metal Oxide Film	SMR02R1J100K 100KOHM 5% 2W 8.6	
		R105	0RD0102F608	Resistor,Carbon Film	RD-96S1J10R0 10OHM 5% 1/6W 3.2	
		R109	0RS0121K619	Resistor,Metal Oxide Film	SMR02R1J1R20 1.2OHM 5% 2W 8.6X	
		R124	0RD2200F608	Resistor,Carbon Film	RD-96S1J220R 220OHM 5% 1/6W 3.	
		R125	0RD2201F608	Resistor,Carbon Film	RD-96S1J2K20 2.2KOHM 5% 1/6W 3	
		R126	0RD1001F608	Resistor,Carbon Film	RD-96S1J1K00 1KOHM 5% 1/6W 3.2	
		R127	0RN3301F408	Resistor,Metal Film	RN-96S1F3K30 3.3KOHM 1% 1/6W 3	
		R128	0RN2701F408	Resistor,Metal Film	RN-96S1F2K70 2.7KOHM 1% 1/6W 3	
		R129	0RD1000F608	Resistor,Carbon Film	RD-96S1J100R 100OHM 5% 1/6W 3.	
		T101	EBJ39634101	Transformer,Switching	EE2621_12pin_1.0mH_10%_SooJung	
		V101	656-004C	Varistor	SVC681D-10A 680V 10% 250pF 10M	
		ZD101	0DZ200009BB	Diode,Zener	MTZJT-7720B 20V 18.63TO19.56V	
		ZD102	0DZ332609AA	Diode,Zener	GDZJ33B 33V 30.32TO31.88V 65OH	
		ZD102	0DZ330009CA	Diode,Zener	MTZJT-7733B 33V 30.32TO31.88V	ALTERNATE
*** PCB Assembly,Main ***						
		A46	EBR38517662	PCB Assembly,Main	LSX300-4DM Main Board 2 Layer	
		CN301	561-711H	Connector,Wafer	GIL-S-08P-S2T2-EF 8P 2.00MM 1R	
		IC303	0IPMGKE018A	IC,LDO Voltage Regulator	KIA78R05PI CU 6TO12V 5V 1.5W T	
		JK200	EAG38742601	Jack,RCA	RCA-357A-00-03 15.0MM 1RX3C ST	
		LD600	EAV41384401	LED Assembly	BL-C52A-B5JDC-07M-AB BLUE, ORA	
		RC600	EAV39117301	Receiver Module	R36FC9A 2.7~6.0V 3MA 38KHZ 15M	
		SW600	EBF38978202	Switch,Tact	THHV701BAA 1C1P 12VDC 0.05A VE	
		SW601	EBF38978202	Switch,Tact	THHV701BAA 1C1P 12VDC 0.05A VE	
		SW602	EBF38978202	Switch,Tact	THHV701BAA 1C1P 12VDC 0.05A VE	
		TU200	EBL38878101	Tuner,Digital	115UBA00AL-F(1F) ATSC 54MHZTO	
		TU200	EBL38878102	Tuner,Digital	TDVG-H051F ATSC 57MHZTO803MHZ	ALTERNATE
		C200	0CH1104K512	Capacitor,Ceramic,Chip	0603B104K500CT 100nF 10% 16V X	
		C201	0CE1074F638	Capacitor,AL,Radial	SRA5.0TP16VB100M 100uF 20% 16V	
		C202	0CH4270K412	Capacitor,Ceramic,Chip	0603N270J500LT 27pF 5% 50V COG	

S	AL	LOCA. NO.	PART NO.	DESCRIPTION	SPECIFICATION	REMARKS
		C203	0CH4270K412	Capacitor,Ceramic,Chip	0603N270J500LT 27pF 5% 50V C0G	
		C205	0CH4270K412	Capacitor,Ceramic,Chip	0603N270J500LT 27pF 5% 50V C0G	
		C206	0CH1103K562	Capacitor,Ceramic,Chip	0603B103K500CT 10nF 10% 50V X7	
		C207	0CH1104K512	Capacitor,Ceramic,Chip	0603B104K500CT 100nF 10% 16V X	
		C208	0CE1066F638	Capacitor,AL,Radial	SMS5.0TP16VB10M 10uF 20% 16V 7	
		C210	0CE1074F638	Capacitor,AL,Radial	SRA5.0TP16VB100M 100uF 20% 16V	
		C211	0CE1074F638	Capacitor,AL,Radial	SRA5.0TP16VB100M 100uF 20% 16V	
		C212	0CH1104K512	Capacitor,Ceramic,Chip	0603B104K500CT 100nF 10% 16V X	
		C213	0CE1074F638	Capacitor,AL,Radial	SRA5.0TP16VB100M 100uF 20% 16V	
		C214	0CE2266F618	Capacitor,AL,Radial	SMS5.0TP16VB22M 22uF 20% 16V 1	
		C215	0CH1104K512	Capacitor,Ceramic,Chip	0603B104K500CT 100nF 10% 16V X	
		C216	0CH1104K512	Capacitor,Ceramic,Chip	0603B104K500CT 100nF 10% 16V X	
		C217	EAE35905501	Capacitor,AL,Chip	RC1C106M04005VR 10uF 20% 16V 1	
		C218	0CE2266F618	Capacitor,AL,Radial	SMS5.0TP16VB22M 22uF 20% 16V 1	
		C219	0CE1066F638	Capacitor,AL,Radial	SMS5.0TP16VB10M 10uF 20% 16V 7	
		C220	0CH1104K512	Capacitor,Ceramic,Chip	0603B104K500CT 100nF 10% 16V X	
		C221	0CE1066F638	Capacitor,AL,Radial	SMS5.0TP16VB10M 10uF 20% 16V 7	
		C222	0CE1066F638	Capacitor,AL,Radial	SMS5.0TP16VB10M 10uF 20% 16V 7	
		C223	0CH1104K512	Capacitor,Ceramic,Chip	0603B104K500CT 100nF 10% 16V X	
		C224	0CE2266F618	Capacitor,AL,Radial	SMS5.0TP16VB22M 22uF 20% 16V 1	
		C225	0CE2266F618	Capacitor,AL,Radial	SMS5.0TP16VB22M 22uF 20% 16V 1	
		C226	0CE2266F618	Capacitor,AL,Radial	SMS5.0TP16VB22M 22uF 20% 16V 1	
		C227	0CC102CF41A	Capacitor,Ceramic,Chip	C1608C0G1C102JT 1nF 5% 16V C0G	
		C228	0CH4181K412	Capacitor,Ceramic,Chip	C1608C0G1H181JT 180pF 5% 50V C	
		C229	0CH1104K512	Capacitor,Ceramic,Chip	0603B104K500CT 100nF 10% 16V X	
		C230	0CH1104K512	Capacitor,Ceramic,Chip	0603B104K500CT 100nF 10% 16V X	
		C231	0CE1066F638	Capacitor,AL,Radial	SMS5.0TP16VB10M 10uF 20% 16V 7	
		C232	0CE1066F638	Capacitor,AL,Radial	SMS5.0TP16VB10M 10uF 20% 16V 7	
		C233	0CE2266F618	Capacitor,AL,Radial	SMS5.0TP16VB22M 22uF 20% 16V 1	
		C234	0CE2266F618	Capacitor,AL,Radial	SMS5.0TP16VB22M 22uF 20% 16V 1	
		C235	0CH1104K512	Capacitor,Ceramic,Chip	0603B104K500CT 100nF 10% 16V X	
		C236	0CH4181K412	Capacitor,Ceramic,Chip	C1608C0G1H181JT 180pF 5% 50V C	
		C237	0CH1104K512	Capacitor,Ceramic,Chip	0603B104K500CT 100nF 10% 16V X	
		C238	0CC102CF41A	Capacitor,Ceramic,Chip	C1608C0G1C102JT 1nF 5% 16V C0G	
		C239	0CE1074F638	Capacitor,AL,Radial	SRA5.0TP16VB100M 100uF 20% 16V	
		C240	0CH4090K112	Capacitor,Ceramic,Chip	C1608C0G1H090DT 9pF 0.5PF 50V	
		C241	0CH4090K112	Capacitor,Ceramic,Chip	C1608C0G1H090DT 9pF 0.5PF 50V	
		C242	0CH1104K512	Capacitor,Ceramic,Chip	0603B104K500CT 100nF 10% 16V X	
		C243	0CH1104K512	Capacitor,Ceramic,Chip	0603B104K500CT 100nF 10% 16V X	
		C244	0CH1104K512	Capacitor,Ceramic,Chip	0603B104K500CT 100nF 10% 16V X	
		C245	0CE4775F638	Capacitor,AL,Radial	SHL5.0TP16VB470M. 470uF 20% 16	
		C246	0CH1105F942	Capacitor,Ceramic,Chip	0603F105Z160CT 1uF -20TO+80% 1	
		C247	0CH1105F942	Capacitor,Ceramic,Chip	0603F105Z160CT 1uF -20TO+80% 1	
		C249	0CH1104K512	Capacitor,Ceramic,Chip	0603B104K500CT 100nF 10% 16V X	
		C302	0CH1104K512	Capacitor,Ceramic,Chip	0603B104K500CT 100nF 10% 16V X	
		C304	0CH4270K412	Capacitor,Ceramic,Chip	0603N270J500LT 27pF 5% 50V C0G	
		C309	0CH1104K512	Capacitor,Ceramic,Chip	0603B104K500CT 100nF 10% 16V X	
		C311	0CH1104K512	Capacitor,Ceramic,Chip	0603B104K500CT 100nF 10% 16V X	
		C313	0CH1104K512	Capacitor,Ceramic,Chip	0603B104K500CT 100nF 10% 16V X	
		C314	0CH1104K512	Capacitor,Ceramic,Chip	0603B104K500CT 100nF 10% 16V X	
		C315	0CH1104K512	Capacitor,Ceramic,Chip	0603B104K500CT 100nF 10% 16V X	
		C316	0CE3363F638	Capacitor,AL,Radial	SRE5.0TP16VB33M 33uF 20% 16V 4	
		C317	0CH1104K512	Capacitor,Ceramic,Chip	0603B104K500CT 100nF 10% 16V X	
		C318	0CH8107F611	Capacitor,AL,Chip	MV6.3TP16VC100M 100uF 20% 16V	
		C319	0CH1104K512	Capacitor,Ceramic,Chip	0603B104K500CT 100nF 10% 16V X	
		C320	0CH1104K512	Capacitor,Ceramic,Chip	0603B104K500CT 100nF 10% 16V X	
		C321	0CE107EF638	Capacitor,AL,Radial	KMG5.0TP16VB100M 100uF 20% 16V	

S	AL	LOCA. NO.	PART NO.	DESCRIPTION	SPECIFICATION	REMARKS
		C322	0CE4775F638	Capacitor,AL,Radial	SHL5.0TP16VB470M. 470uF 20% 16	
		C323	0CH1104K512	Capacitor,Ceramic,Chip	0603B104K500CT 100nF 10% 16V X	
		C324	0CE1074F638	Capacitor,AL,Radial	SRA5.0TP16VB100M 100uF 20% 16V	
		C325	0CE4775F638	Capacitor,AL,Radial	SHL5.0TP16VB470M. 470uF 20% 16	
		C326	0CH1104K512	Capacitor,Ceramic,Chip	0603B104K500CT 100nF 10% 16V X	
		C4000	0CH1104K512	Capacitor,Ceramic,Chip	0603B104K500CT 100nF 10% 16V X	
		C4001	0CE226WF6DC	Capacitor,AL,Chip	MVK5.0TP16VC22M 22uF 20% 16V 3	
		C4002	0CE226F618	Capacitor,AL,Radial	SMS5.0TP16VB22M 22uF 20% 16V 1	
		C4003	0CE226F618	Capacitor,AL,Radial	SMS5.0TP16VB22M 22uF 20% 16V 1	
		C4004	0CE226F618	Capacitor,AL,Radial	SMS5.0TP16VB22M 22uF 20% 16V 1	
		C4005	0CK105BF94A	Capacitor,Ceramic,Chip	C1005Y5V1C105ZT 1uF -20TO+80%	
		C4006	0CK105BF94A	Capacitor,Ceramic,Chip	C1005Y5V1C105ZT 1uF -20TO+80%	
		C4007	0CK105BF94A	Capacitor,Ceramic,Chip	C1005Y5V1C105ZT 1uF -20TO+80%	
		C4008	0CK105BF94A	Capacitor,Ceramic,Chip	C1005Y5V1C105ZT 1uF -20TO+80%	
		C4009	0CK105BF94A	Capacitor,Ceramic,Chip	C1005Y5V1C105ZT 1uF -20TO+80%	
		C4010	0CK105BF94A	Capacitor,Ceramic,Chip	C1005Y5V1C105ZT 1uF -20TO+80%	
		C4011	0CK105BF94A	Capacitor,Ceramic,Chip	C1005Y5V1C105ZT 1uF -20TO+80%	
		C4012	0CK105BF94A	Capacitor,Ceramic,Chip	C1005Y5V1C105ZT 1uF -20TO+80%	
		C4013	0CK104BF94A	Capacitor,Ceramic,Chip	0402F104Z160CT 100nF -20TO+80%	
		C4014	0CK104BF94A	Capacitor,Ceramic,Chip	0402F104Z160CT 100nF -20TO+80%	
		C4015	0CK104BF94A	Capacitor,Ceramic,Chip	0402F104Z160CT 100nF -20TO+80%	
		C4016	0CK104BF94A	Capacitor,Ceramic,Chip	0402F104Z160CT 100nF -20TO+80%	
		C4017	0CK104BF94A	Capacitor,Ceramic,Chip	0402F104Z160CT 100nF -20TO+80%	
		C4018	0CK104BF94A	Capacitor,Ceramic,Chip	0402F104Z160CT 100nF -20TO+80%	
		C4019	0CK104BF94A	Capacitor,Ceramic,Chip	0402F104Z160CT 100nF -20TO+80%	
		C4020	0CK104BF94A	Capacitor,Ceramic,Chip	0402F104Z160CT 100nF -20TO+80%	
		C4021	0CK104BF94A	Capacitor,Ceramic,Chip	0402F104Z160CT 100nF -20TO+80%	
		C4022	0CK104BF94A	Capacitor,Ceramic,Chip	0402F104Z160CT 100nF -20TO+80%	
		C4023	0CK104BF94A	Capacitor,Ceramic,Chip	0402F104Z160CT 100nF -20TO+80%	
		C4024	0CE226F618	Capacitor,AL,Radial	SMS5.0TP16VB22M 22uF 20% 16V 1	
		C4025	0CH1104K512	Capacitor,Ceramic,Chip	0603B104K500CT 100nF 10% 16V X	
		C4026	0CH1104K512	Capacitor,Ceramic,Chip	0603B104K500CT 100nF 10% 16V X	
		C4027	0CH1104K512	Capacitor,Ceramic,Chip	0603B104K500CT 100nF 10% 16V X	
		C4028	0CH1104K512	Capacitor,Ceramic,Chip	0603B104K500CT 100nF 10% 16V X	
		C4029	0CH8107F611	Capacitor,AL,Chip	MV6.3TP16VC100M 100uF 20% 16V	
		C4030	0CE226F618	Capacitor,AL,Radial	SMS5.0TP16VB22M 22uF 20% 16V 1	
		C4031	0CK103BKK6A	Capacitor,Ceramic,Chip	0402B103M500CT 10nF 10% 25V X7	
		C4032	0CK103BKK6A	Capacitor,Ceramic,Chip	0402B103M500CT 10nF 10% 25V X7	
		C4033	0CK103BKK6A	Capacitor,Ceramic,Chip	0402B103M500CT 10nF 10% 25V X7	
		C4034	0CK103BKK6A	Capacitor,Ceramic,Chip	0402B103M500CT 10nF 10% 25V X7	
		C4035	0CK103BKK6A	Capacitor,Ceramic,Chip	0402B103M500CT 10nF 10% 25V X7	
		C4036	0CK103BKK6A	Capacitor,Ceramic,Chip	0402B103M500CT 10nF 10% 25V X7	
		C4037	0CK103BKK6A	Capacitor,Ceramic,Chip	0402B103M500CT 10nF 10% 25V X7	
		C4038	0CK103BKK6A	Capacitor,Ceramic,Chip	0402B103M500CT 10nF 10% 25V X7	
		C4039	0CK103BKK6A	Capacitor,Ceramic,Chip	0402B103M500CT 10nF 10% 25V X7	
		C4040	0CK103BKK6A	Capacitor,Ceramic,Chip	0402B103M500CT 10nF 10% 25V X7	
		C4041	0CK103BKK6A	Capacitor,Ceramic,Chip	0402B103M500CT 10nF 10% 25V X7	
		C4042	0CH1104K512	Capacitor,Ceramic,Chip	0603B104K500CT 100nF 10% 16V X	
		C4043	0CE226F618	Capacitor,AL,Radial	SMS5.0TP16VB22M 22uF 20% 16V 1	
		C4044	0CE226F618	Capacitor,AL,Radial	SMS5.0TP16VB22M 22uF 20% 16V 1	
		C4045	0CK103BKK6A	Capacitor,Ceramic,Chip	0402B103M500CT 10nF 10% 25V X7	
		C4046	0CK103BKK6A	Capacitor,Ceramic,Chip	0402B103M500CT 10nF 10% 25V X7	
		C4047	0CK103BKK6A	Capacitor,Ceramic,Chip	0402B103M500CT 10nF 10% 25V X7	
		C4048	0CK103BKK6A	Capacitor,Ceramic,Chip	0402B103M500CT 10nF 10% 25V X7	
		C4049	0CK103BKK6A	Capacitor,Ceramic,Chip	0402B103M500CT 10nF 10% 25V X7	
		C4050	0CK104BF94A	Capacitor,Ceramic,Chip	0402F104Z160CT 100nF -20TO+80%	
		C4051	0CK104BF94A	Capacitor,Ceramic,Chip	0402F104Z160CT 100nF -20TO+80%	

S	AL	LOCA. NO.	PART NO.	DESCRIPTION	SPECIFICATION	REMARKS	
			C4052	0CH1104K512	Capacitor,Ceramic,Chip	0603B104K500CT 100nF 10% 16V X	
			C4053	0CH1104K512	Capacitor,Ceramic,Chip	0603B104K500CT 100nF 10% 16V X	
			C4054	0CK104BF94A	Capacitor,Ceramic,Chip	0402F104Z160CT 100nF -20TO+80%	
			C4055	0CK104BF94A	Capacitor,Ceramic,Chip	0402F104Z160CT 100nF -20TO+80%	
			C4056	0CK104BF94A	Capacitor,Ceramic,Chip	0402F104Z160CT 100nF -20TO+80%	
			C4057	0CK104BF94A	Capacitor,Ceramic,Chip	0402F104Z160CT 100nF -20TO+80%	
			C4058	0CK104BF94A	Capacitor,Ceramic,Chip	0402F104Z160CT 100nF -20TO+80%	
			C4059	0CK104BF94A	Capacitor,Ceramic,Chip	0402F104Z160CT 100nF -20TO+80%	
			C4060	0CK104BF94A	Capacitor,Ceramic,Chip	0402F104Z160CT 100nF -20TO+80%	
			C4061	0CK104BF94A	Capacitor,Ceramic,Chip	0402F104Z160CT 100nF -20TO+80%	
			C4062	0CK104BF94A	Capacitor,Ceramic,Chip	0402F104Z160CT 100nF -20TO+80%	
			C4063	0CK104BF94A	Capacitor,Ceramic,Chip	0402F104Z160CT 100nF -20TO+80%	
			C4064	0CK104BF94A	Capacitor,Ceramic,Chip	0402F104Z160CT 100nF -20TO+80%	
			C4065	0CK104BF94A	Capacitor,Ceramic,Chip	0402F104Z160CT 100nF -20TO+80%	
			C4066	0CK104BF94A	Capacitor,Ceramic,Chip	0402F104Z160CT 100nF -20TO+80%	
			C4067	0CK104BF94A	Capacitor,Ceramic,Chip	0402F104Z160CT 100nF -20TO+80%	
			C4068	0CK104BF94A	Capacitor,Ceramic,Chip	0402F104Z160CT 100nF -20TO+80%	
			C4069	0CK103BKK6A	Capacitor,Ceramic,Chip	0402B103M500CT 10nF 10% 25V X7	
			C4070	0CK103BKK6A	Capacitor,Ceramic,Chip	0402B103M500CT 10nF 10% 25V X7	
			C4071	0CK103BKK6A	Capacitor,Ceramic,Chip	0402B103M500CT 10nF 10% 25V X7	
			C4072	0CK103BKK6A	Capacitor,Ceramic,Chip	0402B103M500CT 10nF 10% 25V X7	
			C4073	0CK103BKK6A	Capacitor,Ceramic,Chip	0402B103M500CT 10nF 10% 25V X7	
			C4074	0CK103BKK6A	Capacitor,Ceramic,Chip	0402B103M500CT 10nF 10% 25V X7	
			C4075	0CK103BKK6A	Capacitor,Ceramic,Chip	0402B103M500CT 10nF 10% 25V X7	
			C4076	0CK103BKK6A	Capacitor,Ceramic,Chip	0402B103M500CT 10nF 10% 25V X7	
			C4077	0CK103BKK6A	Capacitor,Ceramic,Chip	0402B103M500CT 10nF 10% 25V X7	
			C4078	0CK103BKK6A	Capacitor,Ceramic,Chip	0402B103M500CT 10nF 10% 25V X7	
			C4079	0CK103BKK6A	Capacitor,Ceramic,Chip	0402B103M500CT 10nF 10% 25V X7	
			C4080	0CK103BKK6A	Capacitor,Ceramic,Chip	0402B103M500CT 10nF 10% 25V X7	
			C4081	0CK103BKK6A	Capacitor,Ceramic,Chip	0402B103M500CT 10nF 10% 25V X7	
			C4082	0CK103BKK6A	Capacitor,Ceramic,Chip	0402B103M500CT 10nF 10% 25V X7	
			C4083	0CK103BKK6A	Capacitor,Ceramic,Chip	0402B103M500CT 10nF 10% 25V X7	
			C4084	0CK104BF94A	Capacitor,Ceramic,Chip	0402F104Z160CT 100nF -20TO+80%	
			C4085	0CK104BF94A	Capacitor,Ceramic,Chip	0402F104Z160CT 100nF -20TO+80%	
			C4086	0CK103BKK6A	Capacitor,Ceramic,Chip	0402B103M500CT 10nF 10% 25V X7	
			C4087	0CK104BF94A	Capacitor,Ceramic,Chip	0402F104Z160CT 100nF -20TO+80%	
			C4089	0CH1104K512	Capacitor,Ceramic,Chip	0603B104K500CT 100nF 10% 16V X	
			C4090	0CK104BF94A	Capacitor,Ceramic,Chip	0402F104Z160CT 100nF -20TO+80%	
			C4091	0CH1105F942	Capacitor,Ceramic,Chip	0603F105Z160CT 1uF -20TO+80% 1	
			C4092	0CH1103K562	Capacitor,Ceramic,Chip	0603B103K500CT 10nF 10% 50V X7	
			C4093	0CH1103K562	Capacitor,Ceramic,Chip	0603B103K500CT 10nF 10% 50V X7	
			C4094	0CH4560K412	Capacitor,Ceramic,Chip	0603N560J500LT 56pF 5% 50V C0G	
			C4095	0CH4270K412	Capacitor,Ceramic,Chip	0603N270J500LT 27pF 5% 50V C0G	
			C4096	0CH4270K412	Capacitor,Ceramic,Chip	0603N270J500LT 27pF 5% 50V C0G	
			C4097	0CK104BF94A	Capacitor,Ceramic,Chip	0402F104Z160CT 100nF -20TO+80%	
			C4098	0CK103BKK6A	Capacitor,Ceramic,Chip	0402B103M500CT 10nF 10% 25V X7	
			C4099	0CH1105F942	Capacitor,Ceramic,Chip	0603F105Z160CT 1uF -20TO+80% 1	
			C4101	0CH1104K512	Capacitor,Ceramic,Chip	0603B104K500CT 100nF 10% 16V X	
			C4102	0CH1103K562	Capacitor,Ceramic,Chip	0603B103K500CT 10nF 10% 50V X7	
			C4105	0CK105BF94A	Capacitor,Ceramic,Chip	C1005Y5V1C105ZT 1uF -20TO+80%	
			C4108	0CH1104K512	Capacitor,Ceramic,Chip	0603B104K500CT 100nF 10% 16V X	
			C4110	0CK105BF94A	Capacitor,Ceramic,Chip	C1005Y5V1C105ZT 1uF -20TO+80%	
			C4111	0CK105BF94A	Capacitor,Ceramic,Chip	C1005Y5V1C105ZT 1uF -20TO+80%	
			C4112	0CK105BF94A	Capacitor,Ceramic,Chip	C1005Y5V1C105ZT 1uF -20TO+80%	
			C4113	0CK105BF94A	Capacitor,Ceramic,Chip	C1005Y5V1C105ZT 1uF -20TO+80%	
			C4114	0CK105BF94A	Capacitor,Ceramic,Chip	C1005Y5V1C105ZT 1uF -20TO+80%	
			C4115	0CK105BF94A	Capacitor,Ceramic,Chip	C1005Y5V1C105ZT 1uF -20TO+80%	

S	AL	LOCA. NO.	PART NO.	DESCRIPTION	SPECIFICATION	REMARKS
		C4116	0CK105BF94A	Capacitor,Ceramic,Chip	C1005Y5V1C105ZT 1uF -20TO+80%	
		C4117	0CK105BF94A	Capacitor,Ceramic,Chip	C1005Y5V1C105ZT 1uF -20TO+80%	
		C4118	0CE228WF6DC	Capacitor,AL,Chip	MVK5.0TP16VC22M 22uF 20% 16V 3	
		C500	0CH1104K512	Capacitor,Ceramic,Chip	0603B104K500CT 100nF 10% 16V X	
		C501	0CH1104K512	Capacitor,Ceramic,Chip	0603B104K500CT 100nF 10% 16V X	
		C502	0CH1104K512	Capacitor,Ceramic,Chip	0603B104K500CT 100nF 10% 16V X	
		C503	0CH1104K512	Capacitor,Ceramic,Chip	0603B104K500CT 100nF 10% 16V X	
		C504	0CH1104K512	Capacitor,Ceramic,Chip	0603B104K500CT 100nF 10% 16V X	
		C505	0CH1104K512	Capacitor,Ceramic,Chip	0603B104K500CT 100nF 10% 16V X	
		C506	0CH1104K512	Capacitor,Ceramic,Chip	0603B104K500CT 100nF 10% 16V X	
		C507	0CH1104K512	Capacitor,Ceramic,Chip	0603B104K500CT 100nF 10% 16V X	
		C508	0CH1104K512	Capacitor,Ceramic,Chip	0603B104K500CT 100nF 10% 16V X	
		C509	0CH1103K562	Capacitor,Ceramic,Chip	0603B103K500CT 10nF 10% 50V X7	
		C510	0CH1104K512	Capacitor,Ceramic,Chip	0603B104K500CT 100nF 10% 16V X	
		C511	0CE1066F638	Capacitor,AL,Radial	SMS5.0TP16VB10M 10uF 20% 16V 7	
		C512	0CH1104K512	Capacitor,Ceramic,Chip	0603B104K500CT 100nF 10% 16V X	
		C513	0CH1104K512	Capacitor,Ceramic,Chip	0603B104K500CT 100nF 10% 16V X	
		C514	0CH1104K512	Capacitor,Ceramic,Chip	0603B104K500CT 100nF 10% 16V X	
		CN302	6630XE00204	Connector,FFC/FPC/PIC	04-6232-504-015-800 4P 1.00MM	
		D301	0DRTW00268A	Diode,Rectifier	RS1G 400V 1.3V 5UA 30A 150NSEC	
		IC200	EAN30684801	IC,Video Amplifier	MM1671 2.8VTO5.5V 0.1V 6dB 200	
		IC201	0IPRPCI016A	IC,D/A Converter	CS4344-CZZR 4.75TO5.25V 3TO3.4	
		IC202	0ILNRON005A	IC,OP Amplifier	MC33202DR2 13V 10mV 0.008% 1.2	
		IC301	EAN32789101	IC,LDO Voltage Regulator	LD1117AL-ADJ-TN3AR 15V ADJ 1W	
		IC301	EAN37068001	IC,LDO Voltage Regulator	LM1117RS-ADJ 15V ADJ 1W TO252	ALTERNATE
		IC302	0IPMGUC005A	IC,LDO Voltage Regulator	LD1117A-3.3-A 4.75TO10V 3.3V 1	
		IC304	EAN40230101	IC,LDO Voltage Regulator	TJ3965D-ADJ 6.5V ADJ 1.5W SOP-	
		IC400	EAN32656101	IC,Video Processors	LGDT1111D 1.2VTO1.8V,3VTO3.6V,	
		IC401	0IKE702900F	IC,Voltage Detector	KIA7029AF -0.3TO15V 2.9V 500MW	
		IC403	0ISTLPH026A	IC,CMOS	74LVC14APW 1.2TO3.6V 0.01mA SC	
		IC501	0IMP242560A	IC,EEPROM	24LC256T-I/SM 256KBIT 256KX8BI	
		IC503	0IMMRHY057F	IC,DDR SDRAM	HY5DU561622FTP-D43 256MBIT 4MX	
		L200	6200HJC106A	Filter,Bead	HH-1M2012-121JT 120OHM 2X1.25X	
		L201	6200HJC106A	Filter,Bead	HH-1M2012-121JT 120OHM 2X1.25X	
		L202	6200HJC106A	Filter,Bead	HH-1M2012-121JT 120OHM 2X1.25X	
		L203	6200HJC106A	Filter,Bead	HH-1M2012-121JT 120OHM 2X1.25X	
		L204	6200HJC106A	Filter,Bead	HH-1M2012-121JT 120OHM 2X1.25X	
		L205	6200HJC106A	Filter,Bead	HH-1M2012-121JT 120OHM 2X1.25X	
		L206	6200HJC106A	Filter,Bead	HH-1M2012-121JT 120OHM 2X1.25X	
		L301	6200HJC106A	Filter,Bead	HH-1M2012-121JT 120OHM 2X1.25X	
		L302	0RH0000D622	Resistor,Chip	MCR10EZHJ000 0OHM 5% 1/8W 2012	
		L303	6200HJC106A	Filter,Bead	HH-1M2012-121JT 120OHM 2X1.25X	
		L304	0RH0000D622	Resistor,Chip	MCR10EZHJ000 0OHM 5% 1/8W 2012	
		L305	6200HJC106A	Filter,Bead	HH-1M2012-121JT 120OHM 2X1.25X	
		L306	6200HJC106A	Filter,Bead	HH-1M2012-121JT 120OHM 2X1.25X	
		L400	6200HJC106A	Filter,Bead	HH-1M2012-121JT 120OHM 2X1.25X	
		L401	6200HJC106A	Filter,Bead	HH-1M2012-121JT 120OHM 2X1.25X	
		L402	6200HJC106A	Filter,Bead	HH-1M2012-121JT 120OHM 2X1.25X	
		L403	6200HJC106A	Filter,Bead	HH-1M2012-121JT 120OHM 2X1.25X	
		L404	6200HJC106A	Filter,Bead	HH-1M2012-121JT 120OHM 2X1.25X	
		L405	6200HJC106A	Filter,Bead	HH-1M2012-121JT 120OHM 2X1.25X	
		L406	6200HJC106A	Filter,Bead	HH-1M2012-121JT 120OHM 2X1.25X	
		L407	6200HJC106A	Filter,Bead	HH-1M2012-121JT 120OHM 2X1.25X	
		L408	0LCCE00046A	Inductor,Multilayer,Chip	CI-B1608-221JTT 220NH 5% 50V 2	
		Q200	0TR387509AC	TR,Bipolar	KTC3875S-GR(ALG) NPN 5V 60V 50	
		Q202	0TR387509AC	TR,Bipolar	KTC3875S-GR(ALG) NPN 5V 60V 50	
		Q203	0TR387509AC	TR,Bipolar	KTC3875S-GR(ALG) NPN 5V 60V 50	

S	AL	LOCA. NO.	PART NO.	DESCRIPTION	SPECIFICATION	REMARKS
		Q204	0TR387509AC	TR,Bipolar	KTC3875S-GR(ALG) NPN 5V 60V 50	
		Q205	0TR387509AC	TR,Bipolar	KTC3875S-GR(ALG) NPN 5V 60V 50	
		Q206	0TR387509AC	TR,Bipolar	KTC3875S-GR(ALG) NPN 5V 60V 50	
		Q302	0TR387509AC	TR,Bipolar	KTC3875S-GR(ALG) NPN 5V 60V 50	
		Q304	0TR387509AC	TR,Bipolar	KTC3875S-GR(ALG) NPN 5V 60V 50	
		R200	0RJ0822C678	Resistor,Chip	MCR01MZPJ820 820HM 5% 1/16W 10	
		R201	0RH1001C622	Resistor,Chip	MCR03EZPJ102 1KOHM 5% 1/10W 16	
		R202	0RH1001C622	Resistor,Chip	MCR03EZPJ102 1KOHM 5% 1/10W 16	
		R203	0RH1000C622	Resistor,Chip	MCR03EZPJ101 100OHM 5% 1/10W 1	
		R204	0RH1000C622	Resistor,Chip	MCR03EZPJ101 100OHM 5% 1/10W 1	
		R205	0RH4701C622	Resistor,Chip	MCR03EZPJ472 4.7KOHM 5% 1/10W	
		R206	0RH4701C622	Resistor,Chip	MCR03EZPJ472 4.7KOHM 5% 1/10W	
		R207	0RH1000C622	Resistor,Chip	MCR03EZPJ101 100OHM 5% 1/10W 1	
		R208	0RH1002C622	Resistor,Chip	MCR03EZPJ103 10KOHM 5% 1/10W 1	
		R209	0RH1502C622	Resistor,Chip	MCR03EZPJ153 15KOHM 5% 1/10W 1	
		R212	0RH1002C622	Resistor,Chip	MCR03EZPJ103 10KOHM 5% 1/10W 1	
		R213	0RH1000C622	Resistor,Chip	MCR03EZPJ101 100OHM 5% 1/10W 1	
		R214	0RH1002C622	Resistor,Chip	MCR03EZPJ103 10KOHM 5% 1/10W 1	
		R215	0RH1001C622	Resistor,Chip	MCR03EZPJ102 1KOHM 5% 1/10W 16	
		R217	0RH0682C622	Resistor,Chip	MCR03EZPJ680 680HM 5% 1/10W 16	
		R218	0RH3301C622	Resistor,Chip	MCR03EZPJ332 3.3KOHM 5% 1/10W	
		R220	0RH1001C622	Resistor,Chip	MCR03EZPJ102 1KOHM 5% 1/10W 16	
		R221	0RH1002C622	Resistor,Chip	MCR03EZPJ103 10KOHM 5% 1/10W 1	
		R222	0RH1001C622	Resistor,Chip	MCR03EZPJ102 1KOHM 5% 1/10W 16	
		R223	0RH1002C622	Resistor,Chip	MCR03EZPJ103 10KOHM 5% 1/10W 1	
		R224	0RH1002C622	Resistor,Chip	MCR03EZPJ103 10KOHM 5% 1/10W 1	
		R225	0RH1502C622	Resistor,Chip	MCR03EZPJ153 15KOHM 5% 1/10W 1	
		R226	0RH1001C622	Resistor,Chip	MCR03EZPJ102 1KOHM 5% 1/10W 16	
		R227	0RH1001C622	Resistor,Chip	MCR03EZPJ102 1KOHM 5% 1/10W 16	
		R228	0RH0752C622	Resistor,Chip	MCR03EZPJ750 750HM 5% 1/10W 16	
		R229	0RH1002C622	Resistor,Chip	MCR03EZPJ103 10KOHM 5% 1/10W 1	
		R230	0RH1002C622	Resistor,Chip	MCR03EZPJ103 10KOHM 5% 1/10W 1	
		R231	0RH4703C622	Resistor,Chip	MCR03EZPJ474 470KOHM 5% 1/10W	
		R232	0RH4703C622	Resistor,Chip	MCR03EZPJ474 470KOHM 5% 1/10W	
		R233	0RH4703C622	Resistor,Chip	MCR03EZPJ474 470KOHM 5% 1/10W	
		R234	0RH1001C622	Resistor,Chip	MCR03EZPJ102 1KOHM 5% 1/10W 16	
		R235	0RH1001C622	Resistor,Chip	MCR03EZPJ102 1KOHM 5% 1/10W 16	
		R236	0RH0752C622	Resistor,Chip	MCR03EZPJ750 750HM 5% 1/10W 16	
		R237	0RH1502C622	Resistor,Chip	MCR03EZPJ153 15KOHM 5% 1/10W 1	
		R238	0RH3301C622	Resistor,Chip	MCR03EZPJ332 3.3KOHM 5% 1/10W	
		R239	0RH4701C622	Resistor,Chip	MCR03EZPJ472 4.7KOHM 5% 1/10W	
		R240	0RH4701C622	Resistor,Chip	MCR03EZPJ472 4.7KOHM 5% 1/10W	
		R241	0RH3301C622	Resistor,Chip	MCR03EZPJ332 3.3KOHM 5% 1/10W	
		R242	0RH3301C622	Resistor,Chip	MCR03EZPJ332 3.3KOHM 5% 1/10W	
		R243	0RH1000C622	Resistor,Chip	MCR03EZPJ101 100OHM 5% 1/10W 1	
		R244	0RH1002C622	Resistor,Chip	MCR03EZPJ103 10KOHM 5% 1/10W 1	
		R245	0RH1002C622	Resistor,Chip	MCR03EZPJ103 10KOHM 5% 1/10W 1	
		R246	0RH1002C622	Resistor,Chip	MCR03EZPJ103 10KOHM 5% 1/10W 1	
		R247	0RH4701C622	Resistor,Chip	MCR03EZPJ472 4.7KOHM 5% 1/10W	
		R248	0RH4701C622	Resistor,Chip	MCR03EZPJ472 4.7KOHM 5% 1/10W	
		R249	0RH3301C622	Resistor,Chip	MCR03EZPJ332 3.3KOHM 5% 1/10W	
		R250	0RH1502C622	Resistor,Chip	MCR03EZPJ153 15KOHM 5% 1/10W 1	
		R251	0RH2200C622	Resistor,Chip	MCR03EZPJ221 220OHM 5% 1/10W 1	
		R252	0RH2200C622	Resistor,Chip	MCR03EZPJ221 220OHM 5% 1/10W 1	
		R255	0RH0222C622	Resistor,Chip	MCR03EZPJ220 220HM 5% 1/10W 16	
		R305	0RH1002C622	Resistor,Chip	MCR03EZPJ103 10KOHM 5% 1/10W 1	
		R306	0RH1002C622	Resistor,Chip	MCR03EZPJ103 10KOHM 5% 1/10W 1	

S	AL	LOCA. NO.	PART NO.	DESCRIPTION	SPECIFICATION	REMARKS
		R307	0RH1002C622	Resistor,Chip	MCR03EZPJ103 10KOHM 5% 1/10W 1	
		R308	0RH1002C622	Resistor,Chip	MCR03EZPJ103 10KOHM 5% 1/10W 1	
		R310	0RH1000C622	Resistor,Chip	MCR03EZPJ101 100OHM 5% 1/10W 1	
		R311	0RH1000C622	Resistor,Chip	MCR03EZPJ101 100OHM 5% 1/10W 1	
		R312	0RH1000C622	Resistor,Chip	MCR03EZPJ101 100OHM 5% 1/10W 1	
		R315	0RH1000C622	Resistor,Chip	MCR03EZPJ101 100OHM 5% 1/10W 1	
		R316	0RH1002C622	Resistor,Chip	MCR03EZPJ103 10KOHM 5% 1/10W 1	
		R317	0RH1002C622	Resistor,Chip	MCR03EZPJ103 10KOHM 5% 1/10W 1	
		R318	0RH1002C622	Resistor,Chip	MCR03EZPJ103 10KOHM 5% 1/10W 1	
		R320	0RH0222C622	Resistor,Chip	MCR03EZPJ220 22OHM 5% 1/10W 16	
		R321	0RH1000C622	Resistor,Chip	MCR03EZPJ101 100OHM 5% 1/10W 1	
		R322	0RH1002C622	Resistor,Chip	MCR03EZPJ103 10KOHM 5% 1/10W 1	
		R323	0RH1002C622	Resistor,Chip	MCR03EZPJ103 10KOHM 5% 1/10W 1	
		R324	0RJ1303C477	Resistor,Chip	MCR03EZPF134 130KOHM 1% 1/10W	
		R325	0RH1003C422	Resistor,Chip	MCR03EZPF104 100KOHM 1% 1/10W	
		R326	0RH2201C422	Resistor,Chip	MCR03EZPF222 2.2KOHM 1% 1/10W	
		R400	0RH1002C622	Resistor,Chip	MCR03EZPJ103 10KOHM 5% 1/10W 1	
		R401	0RH1002C622	Resistor,Chip	MCR03EZPJ103 10KOHM 5% 1/10W 1	
		R402	0RH1002C622	Resistor,Chip	MCR03EZPJ103 10KOHM 5% 1/10W 1	
		R403	0RH1002C622	Resistor,Chip	MCR03EZPJ103 10KOHM 5% 1/10W 1	
		R404	0RH1002C622	Resistor,Chip	MCR03EZPJ103 10KOHM 5% 1/10W 1	
		R405	0RH1001C622	Resistor,Chip	MCR03EZPJ102 1KOHM 5% 1/10W 16	
		R406	0RH0222C622	Resistor,Chip	MCR03EZPJ220 22OHM 5% 1/10W 16	
		R407	0RH0222C622	Resistor,Chip	MCR03EZPJ220 22OHM 5% 1/10W 16	
		R408	0RH0222C622	Resistor,Chip	MCR03EZPJ220 22OHM 5% 1/10W 16	
		R409	0RH1001C622	Resistor,Chip	MCR03EZPJ102 1KOHM 5% 1/10W 16	
		R410	0RH1000C622	Resistor,Chip	MCR03EZPJ101 100OHM 5% 1/10W 1	
		R411	0RH1000C622	Resistor,Chip	MCR03EZPJ101 100OHM 5% 1/10W 1	
		R412	0RH3001C622	Resistor,Chip	MCR03EZPJ302 3KOHM 5% 1/10W 16	
		R413	0RH2200C622	Resistor,Chip	MCR03EZPJ221 220OHM 5% 1/10W 1	
		R414	0RH2200C622	Resistor,Chip	MCR03EZPJ221 220OHM 5% 1/10W 1	
		R415	0RH2200C622	Resistor,Chip	MCR03EZPJ221 220OHM 5% 1/10W 1	
		R416	0RH2200C622	Resistor,Chip	MCR03EZPJ221 220OHM 5% 1/10W 1	
		R417	0RH1000C622	Resistor,Chip	MCR03EZPJ101 100OHM 5% 1/10W 1	
		R418	0RH4703C622	Resistor,Chip	MCR03EZPJ474 470KOHM 5% 1/10W	
		R419	0RH4703C622	Resistor,Chip	MCR03EZPJ474 470KOHM 5% 1/10W	
		R420	0RH1000C622	Resistor,Chip	MCR03EZPJ101 100OHM 5% 1/10W 1	
		R421	0RH1000C622	Resistor,Chip	MCR03EZPJ101 100OHM 5% 1/10W 1	
		R422	0RH1002C622	Resistor,Chip	MCR03EZPJ103 10KOHM 5% 1/10W 1	
		R423	0RH1002C622	Resistor,Chip	MCR03EZPJ103 10KOHM 5% 1/10W 1	
		R424	0RH0752C622	Resistor,Chip	MCR03EZPJ750 75OHM 5% 1/10W 16	
		R425	0RH4701C622	Resistor,Chip	MCR03EZPJ472 4.7KOHM 5% 1/10W	
		R426	0RH4701C622	Resistor,Chip	MCR03EZPJ472 4.7KOHM 5% 1/10W	
		R427	0RH1001C622	Resistor,Chip	MCR03EZPJ102 1KOHM 5% 1/10W 16	
		R428	0RH4703C622	Resistor,Chip	MCR03EZPJ474 470KOHM 5% 1/10W	
		R429	0RH1002C622	Resistor,Chip	MCR03EZPJ103 10KOHM 5% 1/10W 1	
		R430	0RH1002C622	Resistor,Chip	MCR03EZPJ103 10KOHM 5% 1/10W 1	
		R431	0RH1002C622	Resistor,Chip	MCR03EZPJ103 10KOHM 5% 1/10W 1	
		R433	0RH1002C622	Resistor,Chip	MCR03EZPJ103 10KOHM 5% 1/10W 1	
		R434	0RH1002C622	Resistor,Chip	MCR03EZPJ103 10KOHM 5% 1/10W 1	
		R435	0RH4701C622	Resistor,Chip	MCR03EZPJ472 4.7KOHM 5% 1/10W	
		R436	0RH1000C622	Resistor,Chip	MCR03EZPJ101 100OHM 5% 1/10W 1	
		R437	0RH1002C622	Resistor,Chip	MCR03EZPJ103 10KOHM 5% 1/10W 1	
		R441	0RH4701C622	Resistor,Chip	MCR03EZPJ472 4.7KOHM 5% 1/10W	
		R500	0RJ1500C678	Resistor,Chip	MCR01MZPJ151 150OHM 5% 1/16W 1	
		R501	0RJ1500C678	Resistor,Chip	MCR01MZPJ151 150OHM 5% 1/16W 1	
		R502	0RJ1500C678	Resistor,Chip	MCR01MZPJ151 150OHM 5% 1/16W 1	

S	AL	LOCA. NO.	PART NO.	DESCRIPTION	SPECIFICATION	REMARKS
		R503	0RJ1500C678	Resistor,Chip	MCR01MZPJ151 150OHM 5% 1/16W 1	
		R504	0RJ1500C678	Resistor,Chip	MCR01MZPJ151 150OHM 5% 1/16W 1	
		R505	0RJ1500C678	Resistor,Chip	MCR01MZPJ151 150OHM 5% 1/16W 1	
		R506	0RJ1500C678	Resistor,Chip	MCR01MZPJ151 150OHM 5% 1/16W 1	
		R507	0RJ1500C678	Resistor,Chip	MCR01MZPJ151 150OHM 5% 1/16W 1	
		R508	0RJ1500C678	Resistor,Chip	MCR01MZPJ151 150OHM 5% 1/16W 1	
		R509	0RJ1500C678	Resistor,Chip	MCR01MZPJ151 150OHM 5% 1/16W 1	
		R510	0RJ1500C678	Resistor,Chip	MCR01MZPJ151 150OHM 5% 1/16W 1	
		R511	0RJ1500C678	Resistor,Chip	MCR01MZPJ151 150OHM 5% 1/16W 1	
		R512	0RJ1500C678	Resistor,Chip	MCR01MZPJ151 150OHM 5% 1/16W 1	
		R517	0RH1002C622	Resistor,Chip	MCR03EZPJ103 10KOHM 5% 1/10W 1	
		R518	0RJ1500C678	Resistor,Chip	MCR01MZPJ151 150OHM 5% 1/16W 1	
		R519	0RJ1500C678	Resistor,Chip	MCR01MZPJ151 150OHM 5% 1/16W 1	
		R520	0RJ1500C678	Resistor,Chip	MCR01MZPJ151 150OHM 5% 1/16W 1	
		R521	0RJ1500C678	Resistor,Chip	MCR01MZPJ151 150OHM 5% 1/16W 1	
		R522	0RJ1500C678	Resistor,Chip	MCR01MZPJ151 150OHM 5% 1/16W 1	
		R523	0RJ1500C678	Resistor,Chip	MCR01MZPJ151 150OHM 5% 1/16W 1	
		R524	0RJ1500C678	Resistor,Chip	MCR01MZPJ151 150OHM 5% 1/16W 1	
		R525	0RJ1500C678	Resistor,Chip	MCR01MZPJ151 150OHM 5% 1/16W 1	
		R526	0RJ0222C678	Resistor,Chip	MCR01MZPJ220 22OHM 5% 1/16W 10	
		R527	0RJ0222C678	Resistor,Chip	MCR01MZPJ220 22OHM 5% 1/16W 10	
		R528	0RJ1500C678	Resistor,Chip	MCR01MZPJ151 150OHM 5% 1/16W 1	
		R529	0RJ1500C678	Resistor,Chip	MCR01MZPJ151 150OHM 5% 1/16W 1	
		R530	0RJ3000C678	Resistor,Chip	MCR01MZPJ301 300OHM 5% 1/16W 1	
		R531	0RH1002C622	Resistor,Chip	MCR03EZPJ103 10KOHM 5% 1/10W 1	
		R533	0RH1002C622	Resistor,Chip	MCR03EZPJ103 10KOHM 5% 1/10W 1	
		R534	0RH0222C622	Resistor,Chip	MCR03EZPJ220 22OHM 5% 1/10W 16	
		R535	0RH0222C622	Resistor,Chip	MCR03EZPJ220 22OHM 5% 1/10W 16	
		R536	0RH1002C622	Resistor,Chip	MCR03EZPJ103 10KOHM 5% 1/10W 1	
		R537	0RH1002C622	Resistor,Chip	MCR03EZPJ103 10KOHM 5% 1/10W 1	
		R538	0RH1002C622	Resistor,Chip	MCR03EZPJ103 10KOHM 5% 1/10W 1	
		R539	0RH1000C622	Resistor,Chip	MCR03EZPJ101 100OHM 5% 1/10W 1	
		R540	0RH1000C622	Resistor,Chip	MCR03EZPJ101 100OHM 5% 1/10W 1	
		R541	0RJ1500C678	Resistor,Chip	MCR01MZPJ151 150OHM 5% 1/16W 1	
		R542	0RJ1500C678	Resistor,Chip	MCR01MZPJ151 150OHM 5% 1/16W 1	
		R543	0RJ1500C678	Resistor,Chip	MCR01MZPJ151 150OHM 5% 1/16W 1	
		R544	0RJ1500C678	Resistor,Chip	MCR01MZPJ151 150OHM 5% 1/16W 1	
		R545	0RJ1500C678	Resistor,Chip	MCR01MZPJ151 150OHM 5% 1/16W 1	
		R546	0RJ1500C678	Resistor,Chip	MCR01MZPJ151 150OHM 5% 1/16W 1	
		R547	0RJ1500C678	Resistor,Chip	MCR01MZPJ151 150OHM 5% 1/16W 1	
		R548	0RJ1500C678	Resistor,Chip	MCR01MZPJ151 150OHM 5% 1/16W 1	
		R549	0RJ1500C678	Resistor,Chip	MCR01MZPJ151 150OHM 5% 1/16W 1	
		R550	0RJ1500C678	Resistor,Chip	MCR01MZPJ151 150OHM 5% 1/16W 1	
		R551	0RJ1500C678	Resistor,Chip	MCR01MZPJ151 150OHM 5% 1/16W 1	
		R552	0RJ1500C678	Resistor,Chip	MCR01MZPJ151 150OHM 5% 1/16W 1	
		R553	0RJ1500C678	Resistor,Chip	MCR01MZPJ151 150OHM 5% 1/16W 1	
		R554	0RJ1500C678	Resistor,Chip	MCR01MZPJ151 150OHM 5% 1/16W 1	
		R555	0RJ1500C678	Resistor,Chip	MCR01MZPJ151 150OHM 5% 1/16W 1	
		R556	0RJ1500C678	Resistor,Chip	MCR01MZPJ151 150OHM 5% 1/16W 1	
		R601	0RH1000C622	Resistor,Chip	MCR03EZPJ101 100OHM 5% 1/10W 1	
		X400	6212AB2250C	Crystal	HC-49/SM 25MHZ 30PPM 25MHZ 30P	
		IC502A	SAA30860603	S/W,Firmware	DTT900 FLASH Program NORTH AME	
*** Frame Assembly ***						
		A44	ADV34656402	Frame Assembly	SETTOP BOX LSX300-4DM MAIN CHA	
		260	MBS39428602	Chassis	PRESS SECC 0.6 LSX300-4DM PRES	
		261	MCQ32325001	Damper	CUTTING RUBBER DVD 07 DVD PLAY	
*** Accessory Assembly ***						

S	AL	LOCA. NO.	PART NO.	DESCRIPTION	SPECIFICATION	REMARKS
		810	6851R-0074D	Accessory Assembly	DVD WW 1WAY YELLOW 1.2M + 2WAY	
		811	6850R-PAA2F	Cable,Assembly	RCA PLUG RCA PLUG 1.2M 1P YELL	
		812	6850R-PBA2H	Cable,Assembly	RCA PLUG RCA PLUG 1.2M 2P RED/	

