

ALINCO

10M FM TRANSCEIVER
DR-M03

6m FM TRANSCEIVER
DR-M06
INSTRUCTION MANUAL

ALINCO, INC.

Head office: "TWIN 21" MID Tower Building 25F
1-61, 2-Chome, Shiromi, Chuo-ku, Osaka 540-8580 Japan
Phone: 06-946-8150 Fax: 06-946-8175 Telex: 63086
E-mail: 101243.1446@compuserve.com
U.S.A.: 438 Amapola Ave., Suite 130, Torrance, CA 90501-6201 U.S.A.
Phone: 310-618-8616 Fax: 310-618-8758
<http://www.alinco.com/>
Germany: Eschborner Landstrasse 55, 60489 Frankfurt am Main, Germany
Phone: 069-786018 Fax: 069-785-60766

INSTRUCTION MANUAL 1
用户手册 15

INTRODUCTION

Thank you for purchasing the ALINCO DR-M03/DR-M06 FM Mobile Transceiver

ALINCO radios and other products are ranked as some of the finest in the world. Your DR-M03/06 has been manufactured with "State of the Art" technology, and tested carefully at the factory. The DR-M03/M06 will give you satisfactory operation for many years.

INNOVATIVE AND NEW FEATURES

The DR-M03/M06 features some of the most advanced features and reliable engineering available anywhere. Our design philosophy at ALINCO is focused on developing innovative usable features, including the following:

- The DR-M03/M06 comes equipped with 50 CTCSS Tone encoders, and with the optional EJ-20U Tone Squelch Decoder Unit, the CTCSS Tones can be decoded for selective receiving.
- 100 Memory Channels
- Programmed Memory Scan, passes over any empty memory channel. In the scan mode, the scan cycle will by-pass any un-programmed channels. That considerable speeds up memory scan especially when the optional memory expansion unit is installed.
- Time Out Timer can be set to a Duty Cycle most accommodating to the users requirements.

INSTRUCTION MANUAL

ACCESSORIES

Carefully unpack your transceiver and you will find the Standard Accessories included:

■ Standard Accessories

1. Hand Microphone (Condenser Type).
2. Mobile Mounting Bracket.
3. Installation Hardware. (4 Black screws 4 Screws 1 Spanner)
(4 Sets Bolt/Nut 2 Fuse)
4. DC Power Cord.

Optional accessories are available, as listed below, at your Authorized ALINCO Dealer. We strongly recommend that you purchase the appropriate accessories to get full features and performance from your radio.

■ Optional Accessories

EJ-20U Tone Squelch Decoder Unit

10M DR - M 0 3
FM MOBILE TRANSCEIVER

6M DR - M 0 6
FM MOBILE TRANSCEIVER

INSTALLATION

Mobile Antenna Installation:

50 Ohm coaxial cable is required for all antenna installations. Mobile antennas require an appropriate mounting base for proper installation and operation. Please refer to the antenna manufacturer's manual for the proper installation and mounting information. After installing your antenna, insure that you have the proper matching and best possible SWR reading. High SWR or improper matching can cause severe damage to your unit.

Caution:

High RF environments can cause severe damage to your unit. Ensure that you are not in a High RF environment when operating the

MOBILE INSTALLATION

1. Location

The transceiver may be installed in any position in your car, where the controls and microphone are easily accessible and safe operation of the vehicle or the performance of the set will not be interfered with. Refer to the diagrams for installation of the Mounting Bracket:

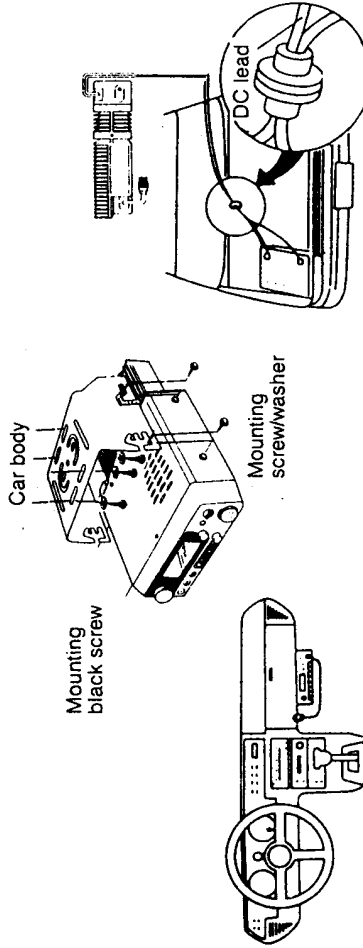

2. Power Requirements

The transceiver can be operated from any regulated 12 or 13.8 V negative ground source. For mobile use, power connections should be made directly to the battery to minimize the possible ignition noise pickup.

BASE STATION INSTALLATION

For fixed base operation, a 13.8 V DC. Power Supply capable of providing at least 5 A continuously is required.

Connect the red lead of the power cable to the Positive (+) terminal, and the black lead to the Negative (-) terminal of the D.C. Power Supply.

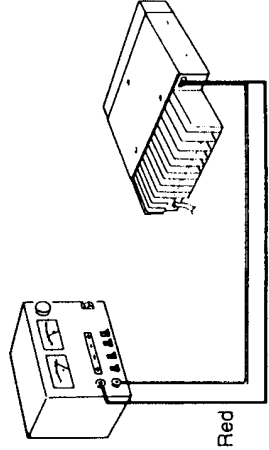

SPECIFICATIONS

All Specifications are for Ham Bands ONLY. No guarantee or warranty, either specific or implied, will apply to any function, feature, or specification outside the Ham Bands. Any modification which causes operation of this unit outside of the Ham Band will result in voiding any warranties associated with this Transceiver.

Specifications are subject to change without notice or obligation.

D R - M O 3

GENERAL

Frequency Coverage:

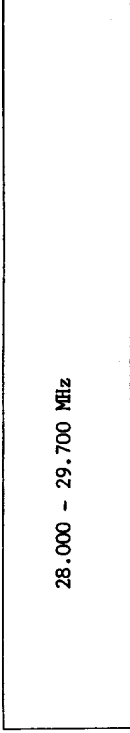

Frequency Resolution:

5, 10, 12.5, 15, 20 & 25 kHz Steps

Antenna Impedance:

50 Ohms Unbalanced

Power Supply Requirements:

13.8 ± 10% Volts DC.

Current Drain at 13.8V:

Receiving: Squelched less than 800 mA

Transmitting: 3 A approx

140mm(W) x 40mm(H) x 115 mm(D)

Dimension:

Approx. 680 gs

Weight:

TRANSMITTER

Output Power:

Hi 10W / Low 1 W

Emission Mode:

F3E (FM)

Modulation System:

Variable Reactance Frequency Modulation

Max. Frequency Deviation:

± 5 kHz

Spurious Emission:

-40 dB or under below carrier

Microphone:

Electret Condenser Microphone

Operation Mode:

Simplex/Semi-Duplex

Offset:

Offset from 0 to 15.995 MHz

RECEIVER

Receiving System:

Superhetrodyne Dual Conversion

Intermediate Frequency:

1st 10.7MHz & 2nd 455 kHz

Sensitivity:

12dB SINAD - 12dBµ

Selectivity:

More than ± 5 kHz at -6dB

Less than ± 12.5 kHz at -60dB

More than 2.5W at 10% Dist.

Audio Power Output:

8 Ohms

Speaker Impedance:

FEATURES

Memory Capacity:

100 Memory Channels

Reverse:

REV

Time Out Timer:

TOT

Priority:

PRI

Repeater Shift:

SHIFT

Channel Step:

CH.SP

Scanning:

(Mic) UP/DOWN

Sub audible Tone:

CTCSS Encoder

57 Hz - 250 Hz with 50 Selections

(Decoder optional)

Power Selection:

H/L

MHz Selection:

MHz

Function:

F

VFO/Memory:

VFO/M

Call Channel:

CALL

Key Lock:

LOCK

OPERATIONS

Controls and Functions

■ Front Panel

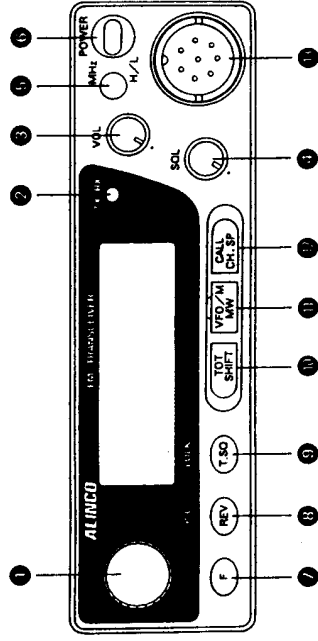

DR - M 0 6

■ GENERAL

Frequency Coverage:

50,000 - 54,000 MHz

Frequency Resolution:

5, 10, 12.5, 15, 20 & 25 kHz Steps

Antenna Impedance:

50 Ohms Unbalanced

Power Supply Requirements:

13.8 ± 10% Volts DC.

Current Drain at 13.8V:

Receiving: Squelched less than 800 mA

Transmitting: HI 3 A approx.

Dimension:

140mm(W) x 40mm(H) x 115mm(D)

Weight:

Approx. 680 gs

■ TRANSMITTER

Output Power:

High: 10w (approx.)

Low: 1w (approx.)

F3E (FM)

Emission Mode:

Variable Reactance Frequency Modulation

± 5 kHz

Modulation System:

-60dB or under below carrier

Max. Frequency Deviation:

Electret Condenser Microphone

Spurious Emission:

Simplex/Semi-Duplex

Microphone:

Offset from 0 to 15,995 MHz

Operation Mode:

Offset from 0 to 15,995 MHz

Offset:

Superhetrodyne Dual Conversion

Receiver System:

1st 10.7MHz & 2nd 455 kHz

Intermediate Frequency:

12dB SINAD - 16dB μ

Sensitivity:

More than ± 6 kHz at -6dB

Less than ± 1.5kHz at -60dB

More than 2.5W at 10% Dist.

Selectivity:

8 Ohms

Audio Power Output:

8 Ohms

Speaker Impedance:

1 MAIN TUNING DIAL

The main tuning dial/knob may be rotated in either direction to select transmit/receive frequencies, memory channels, transmit frequency offsets, and sub-audible tones.

2 TRANSMIT/RECEIVE INDICATOR LAMP

When the PTT is held in the red light goes on. When a signal is received the green light goes on.

3 VOLUME CONTROL

Turn the control knob clockwise to increase the volume, and counterclockwise to decrease the volume.

4 SQUELCH CONTROL

The squelch control knob is used to eliminate noise when no signal is present. Normally this control is adjusted clockwise to the noise threshold level.

5 MHz KEY / H-L KEY

The MHz key is used to change the frequency Up or Down in one MHz steps. With the Func. Key, Output power can be selected.

6 POWER SWITCH

Press to turn On. Press again to turn Off.

7 F KEY / MONI KEY

Func. Key is used to access secondary controlling functions (shown in italics in this manual). Holding this key for over 0.5 sec. MONI is used to open squelch and monitor weak signals.

8 REV / PRI KEY

Reverse is used to invert the TX and RX frequency in Duplex (Repeater) Mode. This is useful for determining whether Duplex Mode is required or not. With the Func. Key, PRI Key selects priority mode, allowing your Priority Channel to be periodically monitored.

9 T.SQ / LOCK KEY

Selects Sub audible Tone. With the Func. Key, Lock Key turns the Lock Function On & Off.

10 TOT / SHIFT KEY

TOT indicates "Time Out Timer". After a set number of minutes in the Transmit Mode the DJ-130 will time out followed by BEEP. (The TOT is disabled while CTCSS tone is encoded unless equipped with the optional EJ-20U.) With the Func. Key, press the Shift Key to select the Repeater Off Set Step and Direction (+ or -).

11 VFO/M / MW KEY

VFO/M Key toggles between VFO (Variable Frequency Oscillator) and Memory Modes. With the Func. Key, MW (Memory Write) stores your selections to a chosen memory channel.

12 CALL / CH.SP KEY

This button is used to access a pre-programmed frequency (memory channel "CALL") with the push of one key. With the Func. Key, CH.SP Key is used to select the desired incremental changes of the receive/transmit frequencies in steps.

Microphone:

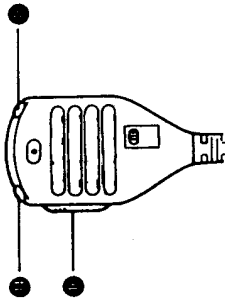

14 & 15 UP & DOWN KEYS

Used to step the VFO, Memory Channels, Off Set Shifts, Tone Selections and, Channel Step Selections Up or Down. Holding one of these keys for 0.5 ~ 3 seconds will activate the timer scan.

16 PTT KEY

The unit transmits when Push To Talk is depressed.

13 MIC CONNECTOR

Connect the supplied microphone to this connector.

REAR PANEL

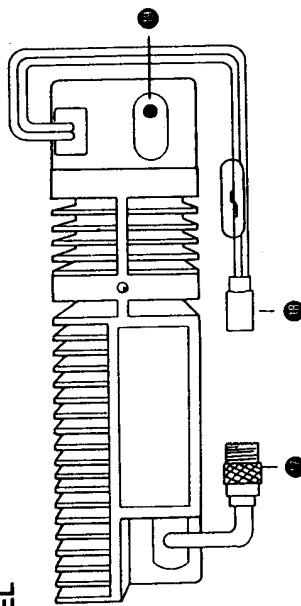

17 Antenna Connector

Used to connect the antenna to the set. Use a PL259 antenna-plug with 50 Ohms impedance.

18 Power Connector

Connect the supplied power cable to this connector.

19 External Speaker Jack

When an external speaker (imp.: 8 Ohms) is used, connect it to this jack.

LCD Display

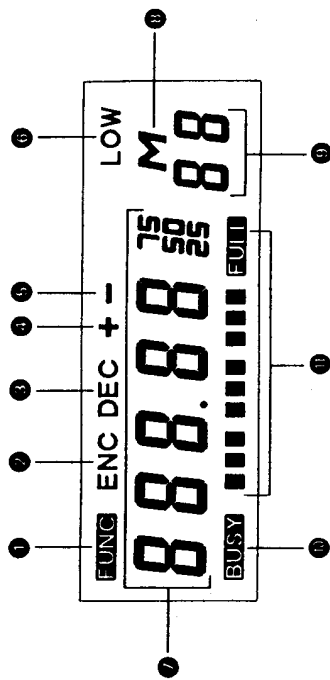

1 FUNCTION IS ON AND SECONDARY FUNCTION KEYS MAY BE ACTIVATED.

Function is on and Secondary function keys may be activated.

2 CTCSS TONE ENCODED.

CTCSS tone encoded. The selected tone will be transmitted with the main carrier.

3 CTCSS TONE DECODED.

CTCSS tone decoded. For selective listening, incoming CTCSS tones will be received and decoded.

4 " + " (TONE DECODE IS AN OPTIONAL FEATURE)

" + " Indicates Up transmitter offset in the Duplex mode.

5 " - " (TONE DECODE IS AN OPTIONAL FEATURE)

" - " Indicates Down transmitter offset in the Duplex mode.

6 LOW

Indicates Low Power transmission. With the display off, transmission is in High Power.

7 88888

Displays the selected transmit/receive frequencies, channel step, Time Out Timer, Offset, or sub audible tone frequencies. Commercial models only. Also can be programmed to display the selected Memory Channel.

8 M

Indicates activation of the Memory Mode.

9 88

Indicates the selected Memory Channel. ("EE" will appear during transmission with CTCSS encoded.)

10 BUSY

Indicates signal being received, and open squelch.

Indicates relative received or transmitted signal strength. (This is for reference purposes only and is not a True indicator of the units sensitivity or received signal strength.)



RECEIVE

- Power On**
Connect to DC (13.8V) Power Supply, and push the POWER Switch.
- Squelch**
Set the squelch control knob to the noise threshold. The BUSY indicator will turn off.
- Frequency Selection**
Turn the Main Dial left or right to select the VFO frequency in kHz, according to the selected channel step value.
Use the MHz Key to select one MHz Up or Down.
- Volume Control**
Use the Volume Control Knob to set the desired audio volume.

TRANSMIT

- Select the desired transmit frequency.
- Hold in the PTT switch and the Transmit Lamp turns on. Speak into the Mic.
- Release the PTT switch and the unit reverts to monitoring mode.
- If the LCD displays "OFF", the transmit frequency has exceeded the transmit range of this unit. No transmit is possible.

PROGRAMMING FUNCTIONS AND FEATURES

RECEIVE AND TRANSMIT MODES

A. VFO Mode (Variable Frequency Oscillator)
Press the VFO/M key. The transceiver will toggle from Memory Mode to VFO Mode. The character "M" and a Memory Channel number disappear. This mode is used to change frequency using the Main Tuning Dial.

B. Memory Mode

Press the VFO/M key. If you are in the VFO Mode the unit will go to Memory Mode. In the Memory Mode, the character "M" and a Memory Channel number are displayed at the right on the LCD. Turning the Main Tuning Dial or pushing the Up/Down Keys on the Mic changes the memory channel. In the Memory Mode you can select a desired memory channel.

Free (empty) memory channels are indicated by the blinking "M" on the LCD.

C. Call Mode

From the VFO Mode or the Memory Mode, you can access your Call Channel by pushing the CALL Key.
A blinking "M" indicates the Call Channel is blank. You can write your chosen frequency, Shift, Tone, etc. to the Call Channel with the same procedures used for Memory Write.

CTCSS TONE SELECTION

(Sub-Audible Tone)
Push the "TSQ" key and the sub-audible tone frequency will display (in kHz) on the LCD. To select a tone, turn the Main Dial or use the Up/Down keys on the Mic. Push the VFO/M Key to return to VFO Mode and, to activate Tone Decode, press the "TSQ" Key before returning to VFO Mode (Optional EJ-20U Tone Squelch Unit required).

Encode/Decode Tones (Hz)

67.0	69.3	71.9	74.4	77.0
79.7	82.5	85.4	88.5	91.5
94.8	97.4	100.0	103.5	107.2
110.9	114.8	118.8	123.0	127.3
131.8	136.5	141.3	146.2	151.4
156.7	159.8	162.2	165.5	167.9
171.3	173.8	177.3	179.9	183.5
186.2	189.9	192.8	196.6	199.5
203.5	206.5	210.7	218.1	225.7
229.1	233.6	241.8	250.3	254.1

SCAN

The DR-M03/DR-M06 has 2 scanning modes. Both scan modes employ Timer Scan system, that is: Scan stops maximum of 5 seconds if a signal is received, and resumes scanning immediately if the signal disappears.

A. VFO Scan

This scan option will scan over the entire tuning range of the band.

- Press the VFO/M Key to select the VFO mode.
- Hold the Up/Down keys on the Mic for 0.5 ~ 3.0 seconds to start scanning.
- To change scan direction, turn the Main Dial opposite to the direction of scan.
- To stop scanning, press the PTT key or the VFO/M key.

B. Memory Scan

This scan option will scan all programmed memory channels.

- Press the VFO/M key to select the memory mode.
- Hold the Up/Down keys on the Mic for 0.5 ~ 3.0 seconds to start scanning.
- To change scan direction, turn the Main Dial opposite to the direction of scan.
- To stop scanning, press the PTT key or the VFO/M key.

PRIORITY

The Priority feature of the DR-M03/DR-M06 will monitor the primary channel for 5 seconds, and then cycle automatically to the secondary channel for 0.5 seconds. Then returns to primary channel, while remains receiving for 2 seconds if signal exists. This convenient feature will allow the user to effectively monitor a secondary channel for activity, almost as if they were monitoring two radios. Press the Func Key and then press the PRI Key to select the Priority feature. When VFO is selected, a "P" will be displayed on the LCD.

A. VFO Priority

VFO Priority sets up VFO as the primary channel. The last selected memory channel is the secondary channel.

B. Memory Priority

Memory Priority sets up your last selected Memory Channel as the primary channel. VFO frequency becomes the secondary channel.

C. Call Priority

Call Priority sets up your programmed Call Channel as the primary channel. The VFO frequency becomes the secondary channel.

■ KEY LOCK FUNCTION

The Key Lock Function locks off most of the features and functions accessible from the touch tone pad and dials.

Push the Func. Key and the Lock-Key to activate Key Lock. The LCD will display "FL" to indicate Key Lock function is on. When Key Lock function is on, only PTT, Power Selection, Monitor, and Key Unlock functions are available. (N.B. "PL" will be displayed if key-locked during the Priority monitor.)

■ SHIFT/REPEATER OFFSET

To select the Shift direction (+ or -) and Off-Set for Repeater operation, press the Func key and then press the TOT Key. The LCD will display a "+ -" mark and show the Off-Set value (in MHz).

A. Selecting and Changing Off-Set Value

Turn the Main Dial or use the Up/Down keys on the Mic to change the Off-Set value. Off-Set can be set from 0-15.995 MHz, and programmed in each memory channel.

B. Setting Shift Direction

By pressing the FUNC Key and then pressing the TOT Key, the "+ -" will change to a "+ +".

To return to VFO, press the VFO/M Key or the PTT Key.

■ MEMORY PROGRAMMING AND OPERATION

To select the Memory Mode, press the VFO/M Key. If you are in VFO the DR-M03/DR-M06 will go to Memory Mode, if you are in Memory Mode, the DR-M03/M06 will go to VFO Mode.

A. Memory Recall

From the VFO Mode select the Memory Mode by pushing the VFO/M Key. The LCD will display a "M" and Channel number when the DR-M03/DR-M06 is in the Memory Mode.

B. Memory Write

1. In the VFO Mode, select the desired Frequency, Shift, Off-Set, Tone, etc.
2. Press the Func Key. A "FUNC" will be displayed on the LCD.

3. Use the Main Dial or the Up/Down Keys on the Mic to select the desired Memory Channel number.
4. Press the MW Key to write to memory.

C. Memory Clear

1. In Memory Mode, press the Func. Key, a "FUNC" is displayed.
2. Select the desired Memory Channel with the Main Dial or Up/Down keys on the Mic.
3. Press the MW Key and the data is cleared from that Memory Channel.

■ CHANNEL STEP

The DR-M03/DR-M06 has six selectable channel steps for VFO programmed in the unit (5k, 10k, 12.5k, 15k, 20k, 25k).

1. Press the Func Key, and then press CH.SP Key. The display will show the current Channel Step setting.
2. Turn the Main Dial or use the Up/Down Keys on the Mic to change the Channel Step to one of the six programmed selections.
3. Push the VFO/M Key or the PTT Key to return to VFO.

** Channel Steps are displayed on the LCD as follows:

- 5 kHz is shown as 5.0
- 10 kHz is shown as 10.0
- 12.5 kHz is shown as 12.5
- 15 kHz is shown as 15.0
- 20 kHz is shown as 20.0
- 25 kHz is shown as 25.0

■ SELECTING TRANSMIT POWER

The DR-M03/DR-M06 has two transmit power levels High (no display) and Low (LOW displayed). High Power is factory set at 10 Watts at 1 watt

To change the Transmit Power selection, press the Func Key and then the MHz Key.

■ OTHER FUNCTIONS AND FEATURES.

1. TOT Time Out Timer

To protect the DR-M03/DR-M06 from excessive transmit, a Time Out Timer has been installed. This can be programmed to activate from 0 seconds to 450 seconds (7.5 Minutes).

Select the Time Out Timer function by pressing the TOT Key, the LCD will display the selected Time Out Time in seconds. Use the Main Dial or the Up/Down Keys on the Mic to change the Time Out setting. Push the VFO/M Key to return to VFO or Memory Mode.

2. REV Reverse

Activating this Function, reverses the selected Off-Set transmit and receive frequencies. This is useful for determining whether to transmit in Semi-Duplex (utilizing a Repeater) or Simplex.

3. Open Squelch

Press and hold the Func key for more than 0.5 seconds and Squelch will open to monitor weak signals. Release Func key to return to Squelch system.

4. Beep

To disable the Beep Tone, turn the unit off. While holding the VFO/M key turn the unit on from the Power Switch. To enable the Beep Tone, repeat the above.

5. Re-Set

To re-set the DR-M03/DR-M06 turn the unit off. While holding the Func Key, turn the unit on from the Power Switch. Re-setting the unit puts all features and functions back to the original factory settings, and erases all memory channels.



FACTORY DEFAULT

Factory Setting*	DR-M03	DR-M06
VFO	29.000 MHz	51.000 MHz
CALL	29.000 MHz	51.000 MHz
Memory Channels	Empty (100 CH)	
Shift	None	
Off Set	0.1 MHz	0.9 MHz
Tone Encode/Decode	Disabled	
Tone Frequency	88.5 Hz	
Channel Step	20 kHz	
Power	High	
Key Lock	Off	
Beep	On	
TOT	Zero	

DR-M03
10 M FM车载式调频对讲机

DR-M06
6 M FM车载式调频对讲机

用户手册

产品介绍	17
创新及新功能	17
附件及选件	17
装配	18
技术特性	19
各部件名称和功能	21
操作控制功能	21
接收	24
发射	24
设定和功能	25
接收和发射方式	25
单音静噪选择	25
扫描	26
优先扫描	26
锁键功能	27
频率偏差方向 / 频率偏差值	26
存储设定及操作	27
信道步距	27
选择发射功率	27
其它功能及特性	27
(1)限时功能	27
(2)反转功能	27
(3)打开静噪	27
(4)“B-B”音	28
(5)重新设定	28

感谢您购买特灵通 DR-M03/DR-M06 FM车载机。
特灵通公司的无线对讲机及其它产品在世界同行业中名列前茅。您所拥有的DR-130车载机经过了精心的制作和测试，将长期提供令您满意的服务。

创新及新功能

DR-M03/DR-M06 的各类创新及可靠的技术体现在各个方面，集中于创新提高各类有效的机能，包括以下各点：

- DR-M03/DR-M06 标准件配备含有50个单音音频的编码器并配有单音静噪解码器的选购件 E-J-20U
- 设定存储信道扫描，跳过空信道。在扫描方式下将跳过未被设定的存储信道。当安装上存储信道扩充系统这一选购件时，扫描速度将远远大于存储信道扫描之速度。
- 具有限时功能。

附件及选购件

仔细打开您的对讲机，您将会发现标准附件包括：

■ 标准附件

- (1)手持麦克风(缩小型)。
- (2)汽车安装支架。
- (3)安装零件。(4个黑螺丝、4个螺丝、1个扳手、4套螺钉/螺母、2根保险丝)
- (4)直流电源线。

■ 选购件

E-J-20U单音静噪解码器

汽车天线安装

天线使用50欧姆的同轴电缆。
请调整天线,使SWR降低(SWR<驻波比),若太高将造成故障。

车载台安装方法

1. 位置:

只要控制器和麦克风易于使用,且不妨碍交通工具的部件或对讲机的性能,您可将对讲机安于任何可安装之处。
以下是汽车安装支架装配示意图

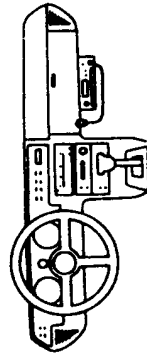

车身

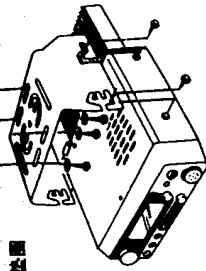

安装用螺丝/垫圈

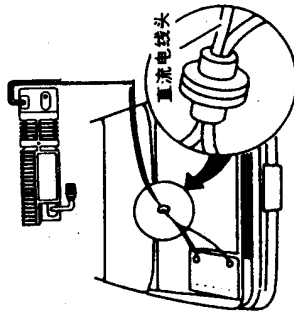

直流电源线头

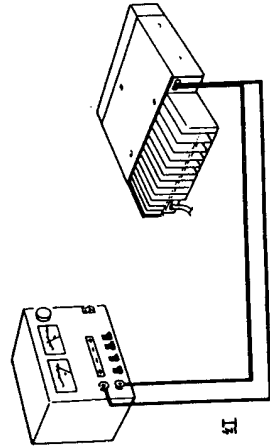

红

基地台安装

为适应基本操作,要求一台13.8V的直流电源有能够连续提供至少 5A 的能力。将电源线的红线接到直流电源的正极,将黑线接到负极。

详细说明:

以下各项说明仅适用于本机所定之规格范围,任何超出范围而引起的变更不属于以下说明之列。

※随着技术的进步,本规格如有变动,恕不预先通知。

DR-M03

一般规格

频率范围

28.000 - 29.700 MHz
(26.000 - 31.000 MHz)

频率间隔.....5, 10, 12.5, 15, 20 & 25kHz
天线阻抗.....50欧姆
电源、电压.....13.8 ± 10% 直流
电流消耗13.8V.....接受: 静噪小于800mA
发射: 高/ 3A (大约)

尺寸.....140mm(W) × 40mm(H) × 115mm(D)
重量.....大约680 g

发射机

输出功率.....高功率 10 W
.....低功率 1 W
发送方式.....F3E(FM)
调制方式.....可变电阻调制
最大频偏.....+ / - 5 KHz
杂波抑制.....小于载波 -40 dB
麦克风.....驻燃体话筒, 低阻抗(约1000欧姆)

频率偏差.....介于 0 - 15.995MHz之间

接收机

接收系统.....超外差二次变频
中 频.....第一为10.7MHz第二为455kHz
灵敏度.....12dB信纳-12 dB μ
选择性.....> ±5 kHz, 在 -6dB
.....< 12.5kHz, 在 -60dB
音频输出.....> 2.5W10%失真
扬声器阻抗.....8 欧姆

※上述参考值,在实际使用过程中,有±10%的误差

50,000 - 54,000 MHz
(46,000 - 56,000)

频率间隔	5, 10, 12.5, 15, 20 & 25kHz
天线阻抗	50欧姆
电源、电压	13.8 ± 10% 直流
电流消耗	接收：静噪小于800mA 发射：高/ 3 A(大约)
尺寸	140mm(W) × 40mm(H) × 115mm(D)
重量	大约 680 g

■ 发射机

输出功率	高功率：10W 低功率：1W(大约)
发送方式	F3E(FM)
调制方式	可变电抗调频
最大频偏	+ / - 5kHz
杂波抑制	小于载波 - 60dB
麦克风	驻燃体话筒，低阻抗(约1000欧姆)
操作方式	单工/双工
频率偏差	介于 0 - 15.995MHz之间

■ 接收机

接收系统	超外差二次变频
中频	第一为 10.7 MHz & 第二为 455kHz
灵敏度	12dB信纳 - 16dB μ
选择性	> ± 6kHz, 在 - 6dB < ± 15kHz, 在 - 60dB > 2.5W/10%失真
音频输出	8 欧姆
扬声器阻抗	8 欧姆

* 上述参考值，在实际使用过程中，有 ± 10% 的误差

■ 性能 DR-M03 / DR-M06

存储信道容量	100
反转	REV
限时	TOT
优先	PRI
中继台频率偏差方向	SHIFT
信道步距	CH. SP
扫描	(麦克风)UP/DOWN
单音音频	CTCSS编码器

介于67Hz - 250Hz的50种选择(解码器选配件)

功率选择	H/L
MHz选择	MHz
功能	F
VFO方式/信道存储方式	VFO/M
呼叫信道	CALL
锁键	LOCK

各部名称和功能

操作控制及功能

■ 前面板

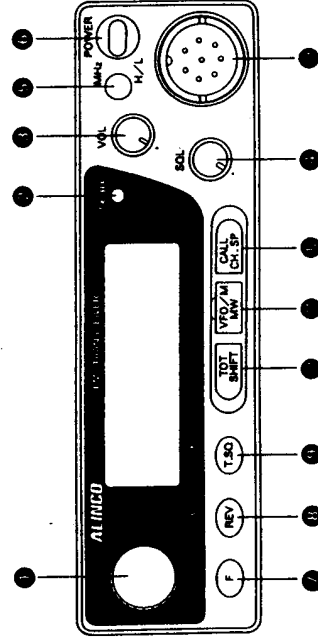

① 主调谐旋钮

用以转变发射/接收频率、存储信道、发射频率偏差及单音频率。

② 发射/接收信号显示灯

发送信号时，红灯点亮；接受信号时，绿灯闪亮。

③ 音量控制

将控制旋钮向顺时针方向旋转增加音量。将控制旋钮向逆时针方向旋转降低音量。

④ 静噪控制

用来在没信号出现时限制噪声，通常是将此旋钮顺时针调至最低噪声处。

⑤ MHz 键、H/L 键

MHz 键是以 1MHz 为单位，增加或降低频率数值的按钮。

按下 H 键后，再按下此键，可进行输出功率的高低转换。

⑥ 电源开关

用于开关电源。

⑦ F/MONI 键

按下功能键 0.5 秒以上，MONI 功能开始运行，打开静噪。

⑧ REV/PRI 键

点(中继台)为全及功时，可使发送频率和接受频率反转。

按下 F 键后再按此键，成为周期性的接受优先信道信号的优先扫描方式。

⑨ T·SQ/LOCK 键

选择单音频率。按下 F 键后，按下此键，可进行锁键功能开/关的转换。

⑩ TOT/SHIFT 键

发送时间可在 30~450 秒之间进行限定 (CTCSS 中不存在这一功能，但若装上 EJ-20U 选配件后，就有这一功能)。按下 F 键后再按此键，能够设定频率偏差方向 + 或 -。

■ 后面板

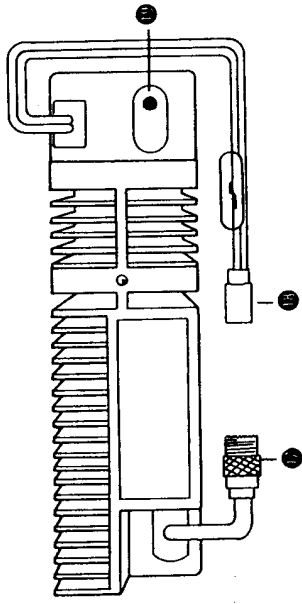

⑦ 天线接口

用以连接天线和喇叭。使用 PL259 的天线插头带有 50 欧姆阻抗。

⑧ 电源接口

以此接口连接电源线。

⑨ 外部扬声器插座

当使用外部扬声器时，将它与此插座相连。

■ 液晶显示

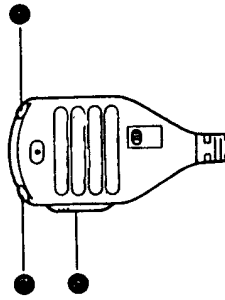

⑬ and ⑮ UP & DOWN 键

用以改变频率和存储信道，连续按住它可进行扫描。

⑯ PTT 键

按下此键，成为信号发送状态。

① FUNC

功能键开始运转, 按下其它键来设定各种功能。

② ENC

单音编码功能起作用。所设定的单音频率同信号一同发射。

③ DEC

表明解码功能起作用, 为选择收听功能而设定。解开所收到的单音编码(只有配备DR-M03/M06的此一功能的选购件才起作用)。

④ "+"

指示双工状态下的"+"向发射频率偏差。显示发送频率变化之方向为"+"。

⑤ "-"

指示双工状态下的 "-" 向发射频率偏差。显示发送频率变化之方向为 "-"。

⑥ LOW

当发送功率为低功率时显示; 消失时表示为高功率。

⑦ 888.88

显示所选定的发送/接收频率, 信道步距, 单音频率, 限定时间和频率偏差。也可显示所选定的存储信道(只适合商业方式)。

⑧ M

显示处于信道存储方式。

⑨ 8 8

显示存储信道号码(当发送单音编码过程中, 这个部分的显示变成"EE")。

⑩ BUSY

接受信号及打开静音时显示。

⑪ 信号显示强度。

接收

(1) 灯开关电源:

接通直流电源(138V), 按下POWER开关。

(2) 静音:

调节静音控制旋钮至噪音消失则BUSY显示消失。

(3) 频率选择:

向左或向右调节主调谐旋钮选择VFO频率, 兼可选择信速步距值。使用MHz键以1MHz为单位向增加或减少方向调节。

(4) 音量控制:

使用音量控制旋钮调节音量。

发射

(1) 选择发射频率。

(2) 按下PTT键, 发射指示灯点亮, 对准麦克风说话。

(3) 松开PTT键, 系统转为监视方式。

(4) 如果液晶显示器显示出"OFF", 表示发射频率已超出系统范围, 不能发射了。

■ 接受及发射方式

A. VFO方式

按下V/M键, 可由存储信道方式转为VFO方式, 这个方式通过主调谐旋钮来改变频率。

B. 存储信道方式

按下V/M键, 若处于VFO方式时则转为存储信道方式。在存储信道方式下, 液晶显示器的右方将显示M和存储信道号, 通过主调谐旋钮或者麦克风风上的UP/DOWN键

单音频率一览表(单位: Hz)

67.0	69.3	71.9	74.4	77.0
79.7	82.5	85.4	88.5	91.5
94.8	97.4	100.0	103.5	107.2
110.9	114.8	118.8	123.0	127.3
131.8	136.5	141.3	146.2	151.4
156.7	159.8	162.2	165.5	167.9
171.3	173.8	177.3	179.9	183.5
186.2	189.9	192.8	196.6	199.5
203.5	206.5	210.7	218.1	225.7
229.1	233.6	241.8	250.3	254.1

来变换存储信道。在存储信道方式下, 可选择您所希望的存储信道。若液晶显示器上出现闪亮的"M"表明是空闲信道。

C. 呼叫方式

按下CALL键, 可从VFO方式或存储信道方式转为呼叫方式。液晶显示器上出现闪亮"M"的呼叫信道为空白。以和存储写入方法相同的方法可写入您所选定的频率、偏移方式、单音频率等。

■ 单音设定

按下[T-SQ]键, 液晶显示器上显示单音频率, 调节主调谐旋钮或使用麦克风风上的UP/DOWN键, 选择一个单音频率。按下VFO键调回VFO方式。

在转换成VFO方式前, 按下T-SQ键一段时间, 单音解码功能即可工作(只有在表上EJ-20J选购件时才有此功能)解码单音频率。

■ 扫描

DR-M03/06具有2种扫描方式。两种扫描方式均使用定时扫描系统，即接收到信号时，扫描最长停止5秒信号一消失，扫描立刻重新开始。

A. VFO扫描

- 这种扫描方式将扫描全体信道。
1. 按下V/M键选择VFO方式。
 2. 按下麦克风上的UP/DOWN键0.5~3秒，扫描开始。
 3. 旋转主调谐旋钮来改变扫描方向。
 4. 按下PTT键或V/M键，停止扫描。

B. 存储扫描

这种扫描方式将扫描全体已设定的存储信道。

1. 按下V/M键选择存储信道方式。
2. 按下麦克风上的UP/DOWN键0.5~3秒，扫描开始。
3. 旋转主调谐旋钮来改变扫描方向。
4. 按下PTT键或V/M键，停止扫描。

■ 优先功能

DR-M03/06的优先功能将监视主信道5秒钟，然后自动地转到下一条信道，监视时间为0.5秒然后返回主信道，如果有信号，则保持接受状态2秒钟。这一功能允许用户能在使用一条信道的同时，同时监视第二条信道，即可同时监视两条信道。先按下[FUNC]键，再按下PRI键来选择优先功能，当处于此功能时，液晶显示器将显示“P”。

A. VFO方式优先功能

VFO方式优先功能设定VFO信道为最初的信道，最后选择的存储信道为第二条信道。

B. 存储方式优先功能

存储方式优先功能设定最后选择的信道为最初的信道，VFO频率成为第二条信道。

C. 呼叫方式优先功能

呼叫方式优先功能将已被设定的呼叫信道定为最初的信道，VFO频率成为第二条信道。

■ 锁键功能

锁键功能可锁住大部分键及旋钮的功能。按下[FUNC]键和[LOCK]键，液晶显示器上将显示“FL”以表示处于锁键状态。当处于锁键状态时，只有PTT功率选择，监视及未锁键功能将不接收锁键。处于优先方式下的锁键状态时，显示器上将显示“PL”。

■ 偏差方向/频率偏差

用于选择偏差方向，及频率偏差。按下[FUNC]键后按下[TOT]键，液晶显示器上将显示“-”号及频率偏差值。

A. 选择及改变频率偏差值

旋转主调谐旋钮或选择麦克风的UP/DOWN键来改变偏差值。频率偏差可被设定0~15.995MHz之内，并可设定在任一信道内。

B. 设定偏差方向

按下[FUNC]键，然后按下[TOT]键，“-”将转为“+”。按下V/M或PTT键，转向VFO方式。

4. 若要关上「B-B」音，先关闭电源，然后在

按住V/M键的同时，打开电源。

若要打开「B-B」音，重复上述动作。

5. 重新设定

重新设定时，先关闭电源，然后在按下F键的同时，打开电源。重新设定时，所有功能均恢复到出厂状态，所有存储信道均被抹掉。

出厂时的频率及其他设定

	VFO DR-M03 DR-M06	29.0 MHz 51.0 MHz	单音编码/解码 单音频率 信道步距	无 88.5Hz 20 kHz
CALL DR-M03 DR-M06	29.0 MHz 51.0 MHz	29.0 MHz 51.0 MHz	功率 键	高 无
存储信道	空	空	「B-B」音	开
偏差方向	无	无	限时功能	0
偏差值 DR-M03 DR-M06	0.1 MHz 0.9 MHz	0.1 MHz 0.9 MHz		

N O T I C E

This equipment has been tested and found to comply with the limits pursuant to Part 15 of the FCC Rules. These limits are designed to provide reasonable protection against harmful interference in a residential installation. This equipment generates, uses, and can radiate radio frequency energy, and if not installed and used in accordance with the instructions, may cause harmful interference to radio communications. However, there is no guarantee that interference will not occur in a particular installation. If this equipment does cause harmful interference to radio or television reception, which can be determined by turning the equipment off and on, the user is encouraged to try to correct the interference by one or more of the following measures.

- *Reorient or relocate the receiving antenna.*
- *Increase the separation between the equipment and receiver.*
- *Connect the equipment into an outlet on a circuit different from that which the receiver is connected.*
- *Consult the dealer or an experienced radio/TV technician for help.*